

Plasdent

Plastic Dental Solutions



information@plasdent.com



NEW PRODUCTS

1

MATRIX & POLISH PRODUCTS

9

STORAGE BINS • SUPPLY CART

13

PRACTICE ENHANCEMENT ORGANIZERS

15

COLOR-CODE SET-UP PRODUCTS

27

EVACUATION & SUCTION PRODUCTS

34

IMPRESSION PRODUCTS

41

ENDODONTIC PRODUCTS

47

IMPLANT

50

SAFETY EYEWEAR

51

FACE SHIELD • DENTAL & LABORATORY APPLIANCE BOXES

52

DENTAL APPLIANCE CLEANSER

52

DENTAL LABORATORY PRODUCTS

56

ORAL HYGIENE PRODUCTS

56

ORTHODONTIC • DISPENSER SYRINGES & GUNS

62

X-RAY PRODUCTS

63

MOUTH PROPS • PLASTIC WEDGES

64

CHEEK RETRACTORS • CAPSULE APPLIER • ACTIVATOR

65

LIGHT SPLASH SHIELDS & HANDLES

66

INTRAORAL PHOTOGRAPHY

67

DENTAL DAM ACCESSORIES

70

COLOR CHART

STANDARD COLORS:



NEON COLORS:



PASTEL COLORS:

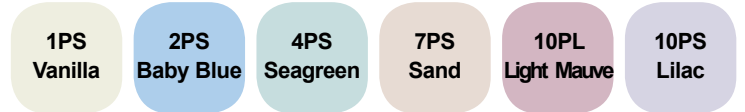

CHROMA™ COLORS:



TROPICAL COLORS:



LITE FLAVOR™ COLORS:

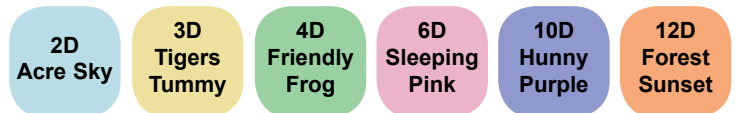

OTHER COLORS:



9.8' STEEL ROLL MATRIX DISPENSER See Page 10



TEFLON ROLL MATRIX DISPENSER See Page 9

SECTIONAL MATRIX See Page 9



MATRIX RINGS See Page 9



CONTOURED ANTERIOR MATRICES See Page 10

STEEL MATRIX RINGS See Page 10



RETAINER & MATRIX See Page 11

65' METALLIC SHIMSTOCK FILM DISPENSER See Page 10



M-TYPE POLISH DISCS KIT

See Page 12



***3M Sof-Lex™ Compatible**

K-TYPE POLISH DISCS KIT

See Page 12



***KerrOptiDisc™ Compatible**

DIAMOND IMPREGNATED POLISH KIT

See Page 12



COMPOSITE POLISH POINTS KIT DIAMOND IMPREGNATED See Page 12



ONE-STEP FINISHING for COMPOSITE

See Page 12

***Dentsply PoGo™ Compatible**



SILICONE POLISHERS
Brown • Green • Super Green
See Page 11

***SHOFU Brownie®, Greenie®, Supergreenie® Compatible**



DISPOSABLE VACUUM TRAPS
See Page 40



DRAWER BOX
See Page 27



**EO STERILE IRRIGATION PRE-TIPPED
3cc SYRINGES** See Page 49



**WALL
MOUNTABLE**



STACKABLE

DIVIDABLE

DRAWER UNITS
See Page 15



ENDO FOAM INSERTS

See Page 50



TRIPLE GLOVE BOX DISPENSER w/SHELVES

See Page 25



ERGONOMIC SPATULAS

See Page 41

EXPAND & FINE DENTAL FLOSS

See Page 58



SINGLE FLUORIDE ARCHES AND TRAYS

See Page 43



BUR BLOCKS AND INSTRUMENTS MATS

See Page 32-33

Silicone

Flexible



LOCKABLE TRAYS AND COVERS

See Page 32



COLORFUL SALIVA EJECTORS

See Page 34



DENTAL APPLIANCE CLEANER
See Page 52



STAINLESS STEEL CHEEK RETRACTOR
See Page 66

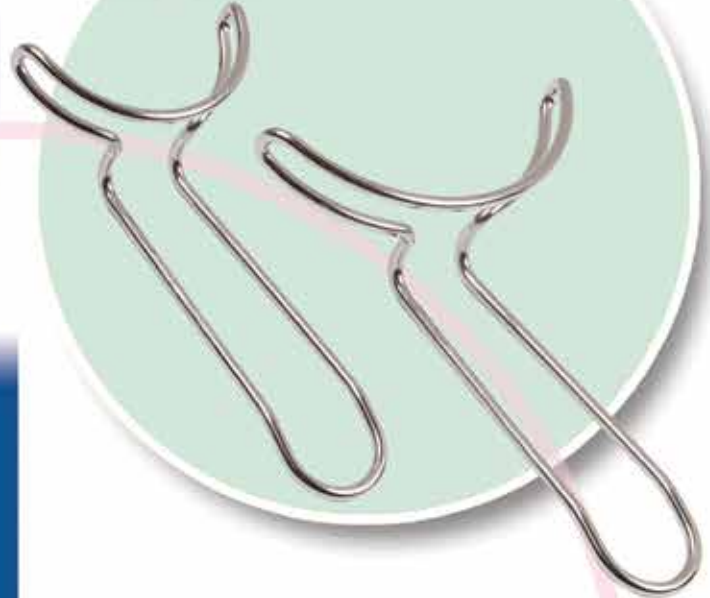

MINI DENTURE BRUSHES
See Page 61



CARTOON TOOTHBRUSH COVERS
See Page 57

ORINGER MOUTH GAP
See Page 66

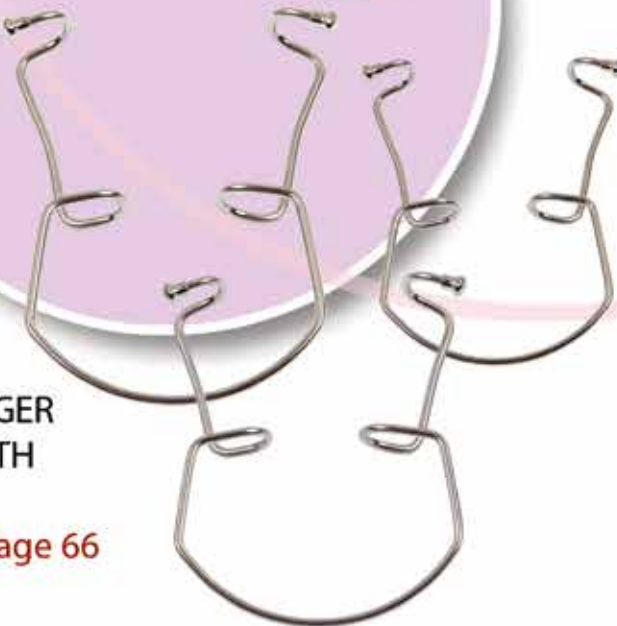

ALIGNER TRAY SEATERS See Page 62



MAXAPPLICATORS II
See Page 42

MIRROR COVERS See Page 28

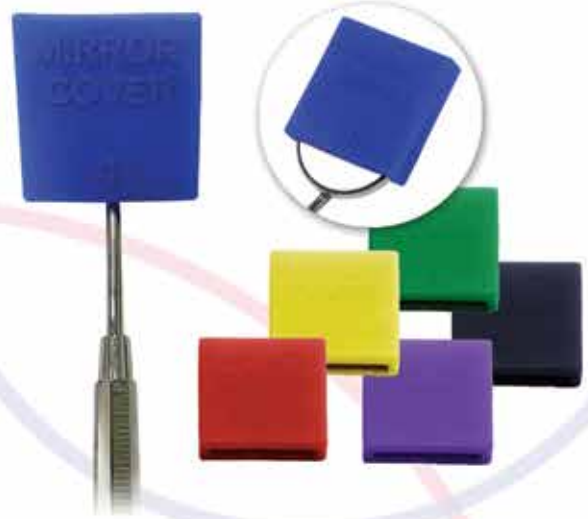

PLASDENT SAFETY EYEWEAR
See Page 51



MOUTH RING & LIP RING RETRACTORS
See Page 65



BIB CLIPS & CHAINS
See Page 35



IMPRESSION TRAYS RACK & TOWER
See Page 47





Excellent™ COLORS BITE TRAYS See Page 46

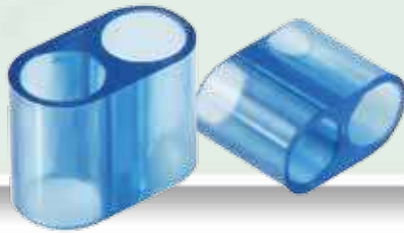

VPS CARTRIDGE CONNECTORS
See Page 39 for KETTENBACH



IMPLANT IRRIGATION KIT See Page 50

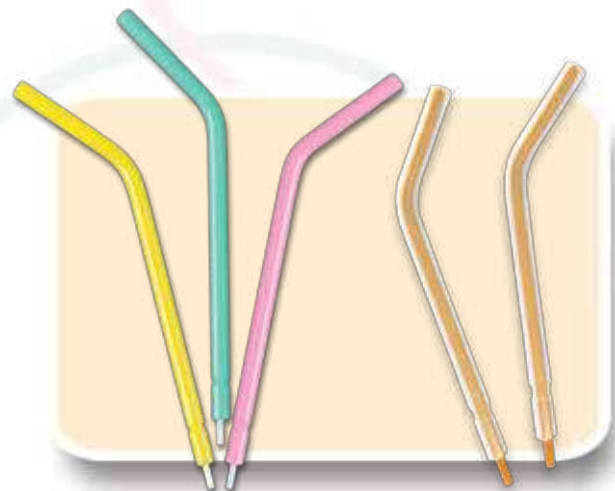

AIR WATER SYRINGE TIPS See Page 38













HEAT MOLDABLE & BIODEGRADABLE
See Page 44



**NEONTRAY™
IMPRESSION TRAYS**
See Page 46





MATRIX & POLISH

EXCELLENT SECTIONAL MATRIX • CONTOURED MATRICES

<p>MTX-64ET</p>  <p>MTX-52</p> 	<p>MTX-64</p>  <p>MTX-45</p> 	<p>MTX-KIT</p>  <p>MTX2-KIT</p> 	<p>MTX2-65</p>  <p>MTX2-45</p>  <p>MTX2-55</p>  <p>MTX2-35</p> 	<p>Palodent® Plus Compatible</p>
<p>Garrison Slick Bands™ Compatible</p>				
<p>MTX-KIT SECTIONAL MATRIX KIT 2 Rings, 30 Matrices \$17.80/box</p> <p>MTX-45 MATRICES 4.5mm BICUSPID (50 pcs/pack)</p> <p>MTX-52 MATRICES 5.2mm MOLAR (50 pcs/pack)</p> <p>MTX-64 MATRICES 6.4mm MOLAR (50 pcs/pack)</p> <p>MTX-64ET MATRICES 8.4mm MOLAR w/EXTENSION (50 pcs/pack) \$12.30/pack of 50</p>		<p>MTX2-KIT SECTIONAL MATRIX KIT II 2 Rings, 30 Matrices \$27.70/box</p> <p>MTX2-35 3.5mm MATRICES (50 pcs/pack)</p> <p>MTX2-45 4.5mm MATRICES (50 pcs/pack)</p> <p>MTX2-55 5.5mm MATRICES (50 pcs/pack)</p> <p>MTX2-65 6.5mm MATRICES (50 pcs/pack) \$26.60/pack of 50</p>		

<p>RIN-PKNA</p> 	<p>RIN-PKSD</p> 	<p>RIN-NTSD</p> 	<p>RIN-NTNA</p> 	
<p>RIN-PKSD: PEEK STANDARD RINGS (12 pcs/pack)</p> <p>RIN-PKNA: PEEK NARROW RINGS (12 pcs/pack)</p>	<p>\$55.60 pack of 12</p>	<p>RIN-NTSD: NICKEL-TITANIUM RINGS UNIVERSAL(2 pcs/pack)</p> <p>RIN-NTNA: NICKEL-TITANIUM RINGS NARROW(2 pcs/pack)</p>	<p>\$106.80 pack of 2</p>	

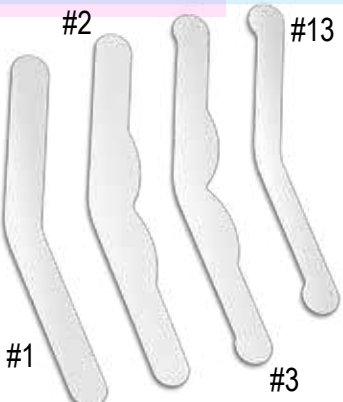
EXCELLENT II SECTIONAL MATRIX • MATRIX BANDS

 <p>MYLAR ROLL MATRIX DISPENSER RM-ML: 45', 9½ mm (¾") x 0.05 mm (0.002") \$4.30/pack</p>			
<p>16' TEFLON ROLL MATRIX DISPENSER RM-TF: 13mm (1/2") X 0.1mm (0.004") \$7.50/ea</p> 		<p>#1 MTXB1-15 0.0015" x 1/4" (0.04mm x 6.5mm) Standard</p> <p>MTXB1-20 0.002" x 1/4" (0.05mm x 6.5mm)</p> <p>#2 MTXB2-15 0.0015" (0.04mm) Wide</p> <p>MTXB2-20 0.002" (0.05mm)</p> <p>#3 MTXB3-15 0.0015" (0.04mm)</p> <p>MTXB3-20 0.002" (0.05mm)</p> <p>#13 MTXB13-15 0.0015" (0.04mm)</p> <p>MTXB13-20 0.002" (0.05mm) \$8.30/bag of 144</p>	

MATRIX & POLISH

9.8'

STEEL ROLL MATRIX DISPENSER



- RM-0525**
5mm X 0.025mm (0.001")
 - RM-0540**
5mm X 0.04mm (0.0016")
 - RM-0550**
5mm X 0.05mm (0.002")
 - RM-0625**
6mm X 0.025mm (0.001")
 - RM-0640**
6mm X 0.04mm (0.0016")
 - RM-0650**
6mm X 0.05mm (0.002")
 - RM-0725**
7mm X 0.025mm (0.001")
 - RM-0740**
7mm X 0.04mm (0.0016")
 - RM-0750**
7mm X 0.05mm (0.002")
- \$4.30/ea**

MSF-0808



- 65' METALLIC SHIMSTOCK FILM DISPENSER**
 - MSF-0808:**
8mm X 8µm
 - MSF-1608:**
16mm X 8µm
- \$12.00/ea**

MSF-1608



MTXB-C5030

MTXB-C5038

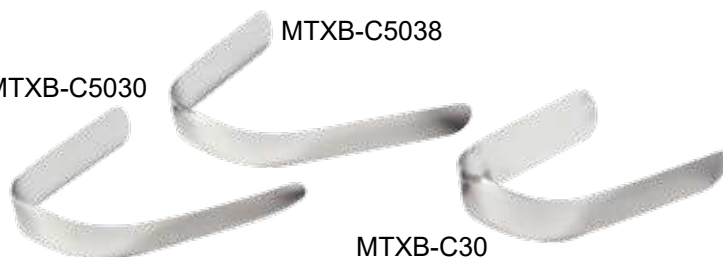

MTXB-C30

TOFFLEMIRE CONTOURED ANTERIOR MATRICES

- MTXB-C5030:** 5mm W X 0.03mm 30 pcs/box
- MTXB-C5038:** 5mm W X 0.038mm 30 pcs/box

- MTXB-C30:** 6.3mm W X 0.03mm 30 pcs/box
 - MTXB-C38:** 6.3mm W x 0.038mm 30 pcs/box
- \$5.40/box**



MTXA-2001

MTXA-2002



MTXA-1501

METAL CONTOURED ANTERIOR MATRICES

- MTXA-2001:** Regular X 0.03mm 30 pcs/box
- MTXA-2002:** Small X 0.03mm 30 pcs/box

\$16.00/box

PLASTIC CONTOURED ANTERIOR MATRICES

- MTXA-1501:** 6-10mm W X 0.05mm 50 pcs/box
- \$26.50/box**



SM5030

SM5038

SM6330

SM6338



STEEL MATRIX RING

50 pcs/box **\$19.50/box**

- SM5030:** 5.0mm X 0.03mm (0.0012")
- SM6330:** 6.3mm X 0.03mm (0.0012")

- SM5038:** 5.0mm X 0.038mm (0.0015")
- SM6338:** 6.3mm X 0.038mm (0.0015")

MATRIX & POLISH



Curved Adjustable Band 180° Bendable Head

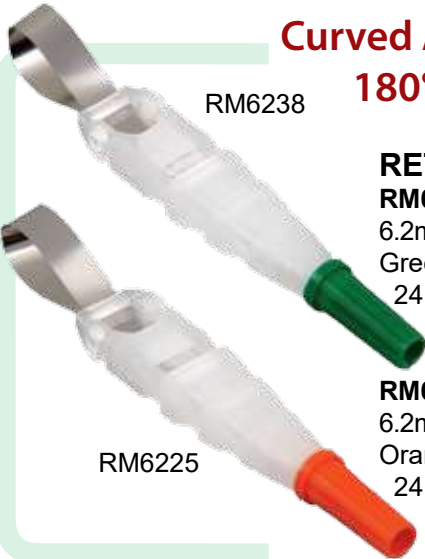

RM6238

RETAINER & MATRIX

RM6238:
6.2mm x 0.038mm (0.0015")
Green,
24 pcs/box **\$28.40/box**

RM6225

RM6225:
6.2mm x 0.025mm (0.001")
Orange,
24 pcs/box **\$28.40/box**



RM4838

RETAINER & MATRIX

RM4838:
4.8mm x 0.038mm (0.0015")
Purple,
24 pcs/box **\$28.40/box**

RM-ML6275

MYLAR RETAINER & MATRIX

RM-ML6275:
6.2mm x 0.075mm (0.00295")
Red,
24 pcs/box **\$28.40/box**

Shofu® Super-Snap Compatible



PDS0100

SNAP-ON POLISH DISCS KIT
4 Mandrels, 100 Discs **\$26.90/box**

PDS0101

SNAP-ON POLISH DISCS (100 pcs/pack)
White, X-Fine **\$22.60/pack of 100**

PDS0102

SNAP-ON POLISH DISCS (100 pcs/pack)
Blue, Fine **\$22.60/pack of 100**

PDS0103

SNAP-ON POLISH DISCS (100 pcs/pack)
Mauve, Medium **\$22.60/pack of 100**

PDS0104

SNAP-ON POLISH DISCS (100 pcs/pack)
Black, Coarse **\$22.60/pack of 100**

PDS01-MR

STANDARD MANDRELS (10 pcs/pack)

PDS01-MS

SHORT MANDRELS (10 pcs/pack)

\$8.20/pack of 10



GR-01FG:
SILICONE POLISHERS for Polishing
Green, 12 pcs/box **\$17.30/box**

SG-01FG:
SILICONE POLISHERS for Super Polishing
Super Green, 12 pcs/box **\$17.30/box**

BR-01FG:
SILICONE POLISHERS for Pre-Polishing
Brown, 12 pcs/box **\$17.30/box**

POLISHING STRIP ROLL



PSR-M:
1/8" W (Medium)

PSR-F:
1/8" W (Fine)

\$10.10/pack

SUPER BUFF DISCS KIT



SPD-1
PASTE-IMPREGNATED DISCS

- For Composite Polishing
- Moisten Before Use
- Recom 8000-12000/Max15000/CP 0.8N

\$20.30
box of 50 discs
2 mandrels

MATRIX & POLISH



M-TYPE POLISH DISCS KIT

PDS-3M0950 PDS-3M1270

K-TYPE POLISH DISCS KIT

PDS-KR0950 PDS-KR1250

PDS-3M0950: 3/8", 2 Mandrels, 40 Discs
PDS-3M1270: 1/2", 2 Mandrels, 40 Discs **\$16.00/box**

PDS-KR0950: 3/8", 2 Mandrels, 40 Discs
PDS-KR1250: 12.5mm, 2 Mandrels, 40 Discs **\$12.00/box**

PDS-3MRE: M Type Standard Mandrels, 3pcs **\$9.00/bag**
PDS-KRRE: K Type Standar Mandrels, 3 pcs
PDS-KRST: K Type Short Mandrels, 3 pcs **\$9.00/bag**



DIAMOND IMPREGNATED POLISH KIT

SPD-0501:
 5/16", for **CERAMICS**,
 6 pcs/box (2C,2M,2F) **\$30.00/box**

SPD-0505:
 5/16", for **COMPOSITE**,
 6 pcs/box (3 Medium, 3 Fine) **\$20.00/box**



COMPOSITE POLISH POINTS KIT DIAMOND IMPREGNATED

SPD-1100:
 8 pcs/box 4 Polish, 4 Finish
\$20.00/box



ONE-STEP FINISHING for COMPOSITE

SPD-1301: DISCS, 40 pcs/box
SPD-1302: CUPS, 40 pcs/box
SPD-1303: POINTS, 40 pcs/box

\$28.50/box

STORAGE BINS



STB-T2:
Tall Storage Bin, White,
8.27"W x 14.76"D x 7"H,
\$13.50/ea

STB-T1:
Tall Storage Bin, White,
8.27"W x 10.87"D x 7"H,
\$12.10/ea



STB-S1:
Small Storage Bin, White,
4.13"W x 5.39"D
x 3"H, \$3.30/ea



STB-S2:
Small Storage Bin, White,
4.13"W x 7.36"D
x 3"H, \$3.60/ea



with Divider



STB-L2:
Large Storage Bin, White,
16.54"W x 14.76"D x 7"H, \$21.90/ea



STB-L1:
Large Storage Bin, White,
10.98"W x 10.87"D x 5"H, \$14.10/ea



STB-M1:
Medium Storage Bin, White,
5.51"W x 10.87"D x 5"H,
\$8.50/ea



Hanging Panels

STB-HP: White, 23.66"W x 17.80"H, \$60.00/box of 2 pcs

Accessories



Riser Leg:
All Bins come with 4 Riser Legs



Divider:
Come with STB-L1 and STB-L2 only

COLORFUL POWDER PAINT METAL CART, for QUALITY GUARANTEE

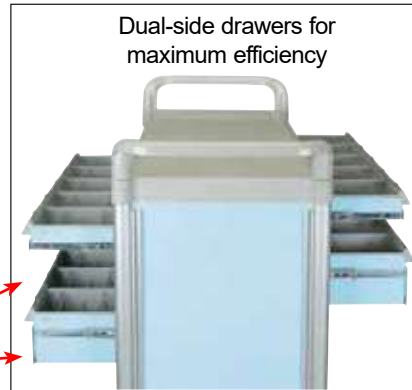

3" drawer with removable trays and dividers



6" drawer with removable trays and dividers



Key-locks control drawers on each side

All trays are easy to remove and replace

ITEM	DESCRIPTION	PRICE
SUP34-#	Supply Cart	\$935.00

SUPPLY, STORAGE & CADDY



MOBILE STORAGE CART

SUP03-1:
White, 12"W X 15 3/4"D X 24 1/2"H \$205.00/ea



SUPPLY CART

SUP01-1:
White, 31 1/4"W X 18 3/4"D X 38"H \$230.00/ea



MINI SUPPLY CART

SUP02-1:
White, 16 3/4"W X 15 1/4"D X 32"H \$75.00/ea



SUPPLY CADDY w/LID

SUP04-1:
White, 12 3/4"W X 6"D X 5 1/4"H \$22.00/ea

PRACTICE ENHANCEMENT ORGANIZERS

FOR ORGANIZATION AND PROTECTION

BENCHTOP CABINETS



6-DRAWER UNIT 14 7/8"W x 7 1/2"H x 6 1/16"D
DRA06-11:
 Black Frame \$25.00/ea



10-DRAWER UNIT 14 7/8"W x 7 1/2"H x 6 1/16"D
DRA10-11:
 Black Frame \$28.70/ea



12-DRAWER UNIT 14 7/8"W x 7 1/2"H x 6 1/16"D
DRA12-11:
 Black Frame \$30.00/ea



MINI 6-DRAWER UNIT
DRA06M-11:
 Black Frame \$14.00/ea
 9 3/16"W x 5 13/16"H x 6 1/16"D



MINI 9-DRAWER UNIT
DRA09M-11:
 Black Frame \$14.80/ea
 9 3/16"W x 5 13/16"H x 6 1/16"D

20-DRAWER UNIT



DRA20-11:
 Black frame
DRA20-1:
 White Frame
 \$33.20/ea

14 7/8"W x 7 1/2"H x 6 1/16"D

14-DRAWER UNIT



DRA14-11:
 Black frame
DRA14-1:
 White Frame
 \$53.20/ea

17 5/8"W x 9 5/8"H x 7 1/8"D

8-BIN UNIT

11¹³/₁₆"W x 8"H x 3³/₈"D



BIN08-11:

Black frame/ Gray bins

BIN08-1:

White frame/ White bins

\$28.90/ea

6-BIN UNIT

11¹³/₁₆"W x 10"H x 4"D



BIN06-11:

Black frame/ Gray bins

BIN06-1:

White frame/ White bins

\$33.20/ea

ADAPTABLE FOUR-SIDE EASY CONNECTION

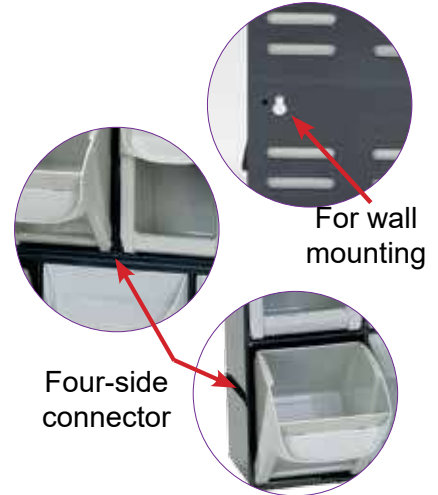

For wall mounting

Four-side connector

5-BIN UNIT

23⁵/₈"W x 6"H x 4³/₄"D



BIN05-11:

Black frame/ Gray bins

BIN05-1:

White frame/ White bins

\$49.90/ea

4-BIN UNIT



23⁵/₈"W x 8"H x 6¹/₂"D

BIN04-11:

Black frame/ Gray bins

BIN04-1:

White frame/ White bins

\$66.60/ea

★ DENTAL ACCESSORIES DRAWER

- Comes with a clear display screen

- Stackable & Locked

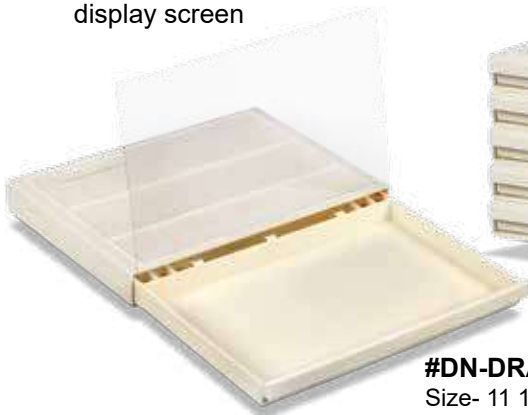

#DN-DRAWER(P)

Size- 11 1/8"L x 8 3/8"W x 1 1/4"H

Color- Beige

\$27.10/ea



- Designated area for logo branding



GLOVE DISPENSER BULK LOAD

208GLD: 11 5/8"W x 7"H x 4"D

White, wall-mount or desktop

\$34.30/ea

PRACTICE ENHANCEMENT ORGANIZERS

BIB HOLDER



1204

1205

1204:
Short side loading
6 1/4"W x 6"H x 8"D
\$23.70/ea

1205:
Long side loading
8"W x 5 3/4"H x 5 1/2"D
\$23.70/ea



1205-C

1205-C:
Long side loading w/cover
5 5/8"W x 7 1/2"H x 6 3/10"D
\$26.80/ea

1212

1211



MOLDED FACE MASK ORGANIZER
1211:
6 1/2"W x 7 1/4"H x 5 5/8"D
\$25.80/ea

EARLOOP FACE MASK ORGANIZER
1212:
8 1/2"W x 5 1/4"H x 5"D
\$25.80/ea

1206-S

1206



MULTI-FOLD TOWEL HOLDER
1206-S:
10 1/2"W x 5 3/4"H x 4 1/4"D
\$23.80/ea

C-FOLD TOWEL HOLDER
1206:
11 7/8"W x 5 3/4"H x 4 1/4"D
\$23.70/ea

1208

1207



SMALL WALL ORGANIZER
1208:
8 1/4"W x 3"H x 3 1/2"D
\$13.80/ea

LARGE WALL ORGANIZER
1207:
16 1/4"W x 3"H x 5 1/4"D
\$21.70/ea

ACRYLIC CUP DISPENSER: for 5oz cups

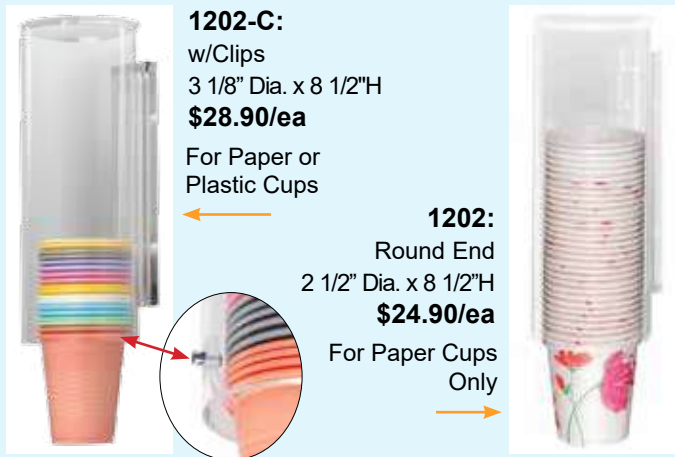

1202-C:
w/Clips
3 1/8" Dia. x 8 1/2"H
\$28.90/ea
For Paper or Plastic Cups

1202:
Round End
2 1/2" Dia. x 8 1/2"H
\$24.90/ea
For Paper Cups Only

1870

1870TH

1860:
CURING SHIELD
4 7/8"W x 10"L
\$18.60/ea

1860TH:
TOOTH CURING SHIELD
5 1/2"W x 11"L
\$21.50/ea

1870:
HAND MIRROR
4 7/8"W x 10"L
\$15.00/ea

1870TH:
TOOTH HAND MIRROR
5 1/2"W x 11"L
\$18.80/ea

1860

1860TH

WALL MOUNT

1310

1300



VERTICAL TISSUE BOX DISPENSER
1300: 4 3/4"W x 9"L x 2"D \$20.80/ea
1310: 4 3/4"W x 9"L x 3 1/2"D \$22.80/ea
1330: 4 3/4"W x 9"L x 4 3/4"D \$25.80/ea

WALL MOUNT

1310H

1350



HORIZONTAL & SQUARE TISSUE BOX DISPENSER
1300H: 4 3/4"W x 9"L x 2"D \$20.80/ea
1330H: 4 3/4"W x 9"L x 4 3/4"D \$25.80/ea
1310H: 4 3/4"W x 9"L x 3 1/2"D \$22.80/ea
1350: SQUARE DISPENSER \$17.90/ea

PRACTICE ENHANCEMENT ORGANIZERS



ANESTHETIC CARTRIDGE HOLDER

1410:
3"H x 3 1/2" Diam.
Holds 50, 1.8 ml
anesthetic cartridges

\$21.80/ea

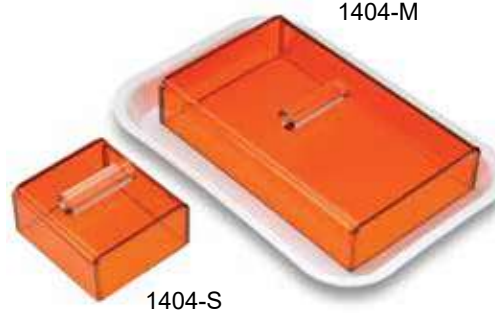

ULTRAVIOLET COVER

1404-M:
7 1/2"L x 4 1/2"W
x 1 1/2"H
\$20.70/ea

1404-S:
3 1/4"L x 3"W x 1"H
\$14.70/ea

UPRIGHT IMPRESSION GUN HOLDER



1406:
Triple
11"W x 7 1/4"H x 6 1/2"D
\$32.60/ea

1407:
Dual
7 1/4"W x 7 1/4"H x 6 1/2"D
\$27.60/ea

STRAIGHT IMPRESSION GUN HOLDER



1408:
Triple
10 7/8"W x 5"H x 6"D
\$33.70/ea

1409:
Dual
7"W x 5"H x 6"D
\$25.80/ea

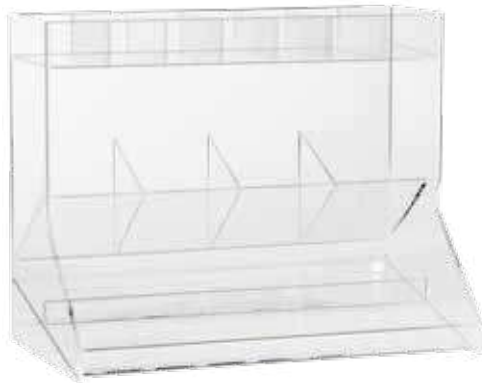

ORGANIZATION STATION

1413:
14"W x 11"H x
7 1/4"D
\$94.30/ea



JUMBO ORGANIZATION RACK

1414:
15 1/4"W x 17 1/2"H
x 5 1/8"D
\$159.00/ea



IMPRESSION ORGANIZER

1411:
12 1/4"W x 9 1/2"H
x 6"D
\$57.60/ea



ADJUSTABLE COMPARTMENT ORGANIZER

1412:
12"W x 11 3/4"H
x 7 1/8"D
\$107.30/ea





RESPIRATORY HYGIENE STATION

1900:
15"W x 12"H x 5 1/2"D

\$70.30/ea



SPLASH WORK STATION

1418:
12"W x 8"H x 8 5/8"D

\$57.60/ea

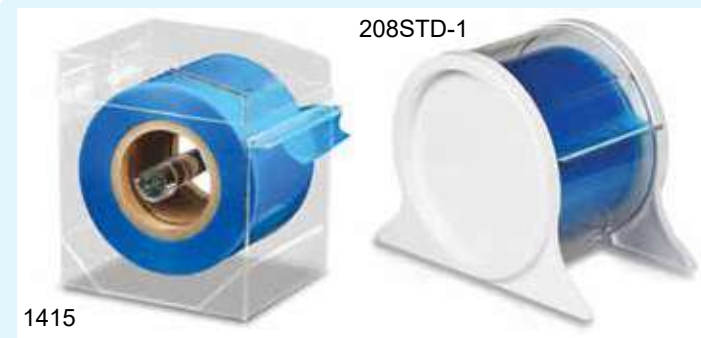

1415

1415: STICKY WRAP DISPENSER **\$33.70/ea**

Note: Core of wrap needs to be 2 7/8" or bigger to fit the dispenser
5 1/2"W x 7 1/8"H x 6 1/4"D

208STD-1: BARRIER FILM DISPENSER **\$23.60/ea**

5 1/4"W x 7"H x 9 1/2"D



IT8-RACK: SYRINGES BRACKET
5 1/2"W x 4"H x 3 3/8"D

\$14.80/ea



1416: WIPES CANISTER HOLDER
6 1/2"W x 5 1/4"H x 5 1/4" Diam.

\$24.90/ea



1417-6



1417-2

1417-4

1417-2: TWO IMPRESSION GUN ORGANIZER **\$34.80/ea**

5 3/4" x 6 5/8" x 7 1/2"

1417-4:

FOUR IMPRESSION GUN ORGANIZER **\$58.70/ea**

11 3/8" x 6 5/8" x 7 1/2"

1417-6:

SIX IMPRESSION GUN ORGANIZER **\$82.60/ea**

17" x 6 5/8" x 7 1/2"

PREMIUM COMPOSITE SYRINGE ORGANIZER

1403

1402



1402:
7 1/2"W x 5 1/2"H x 4 1/2"D
\$30.60/ea

1403: Mini
4 3/8"W x 5 1/2"H x 4 1/2"D
\$22.70/ea

1209

1210

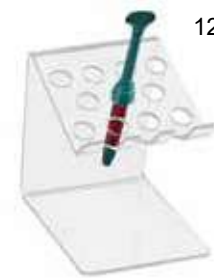

LARGE COMPOSITE MATERIAL ORGANIZER

1209: 8"W x 5 1/8"H x 4 1/4"D
\$25.50/ea

SMALL COMPOSITE MATERIAL ORGANIZER

1210: 4"W x 5 1/8"H x 4 1/4"D
\$20.60/ea

PRACTICE ENHANCEMENT ORGANIZERS



**1014:
UNICYCLE
DISPENSER**
10 1/2"W x 5 1/2"D
x 5 1/2"H
\$78.50/ea



**1010-CR:
PLIER RACK
w/COVER**
8"W x 6 1/2"D
x 8"H
\$52.10/ea



208BTB: BUR TUB
Beige color only
2 1/2"H x 3 1/2" Diam.
\$9.60/ea



**1015:
UNICYCLE & CHAIN
RACK**
6 3/4"W x 9"D x 5 1/2"H
\$71.60/ea



**1016:
CHAIN ELASTIC
DISPENSER**
9 7/8"W x 3 7/8"D x 4 1/4"H
\$45.30/ea



1013: BRACKET TRAY HOLDER
6 1/2"W x 6"H x 3"D
Smoke color, Holds 10 trays
\$42.50/ea



GERMICIDE TRAY
10 3/8"W x 3 1/4"H x 4"D
208GST-2: Blue with clear lid
208GST-1: White with clear lid

\$22.00/ea



**CUP DISPENSER
WALL MOUNT
208CPD:**
White and Beige,
for 5oz cups
\$21.90/ea

**Adhesive
Backed**



ORTHO BRACKET TRAYS
BT2003-1: White
BT2003-2X: Blue
BT2003-4X: Green
BT2003-4T: Turquoise
disposable, 25 pcs/box
\$18.30/box



**1004:
ROUND PLIER RACK
w/ Holding Tube**
4" Dia x 4 1/4"H w/ 1 1/4"
Holding tube inserted
\$23.70/ea

**1005:
SMALL ROUND
PLIER RACK**
3 1/2" Dia x 4"H
\$18.70/ea

**1006:
LARGE ROUND
PLIER RACK**
4" Dia x 4 1/4"H
\$21.60/ea



**1010:
DOUBLE STRAIGHT
PLIER RACK**
7 3/4"W x 8 3/4"L x 4 1/2"H
\$46.90/ea

**1011:
SINGLE STRAIGHT
PLIER RACK**
5 1/8"W x 8 1/2"L x 4"H
\$34.30/ea

PRACTICE ENHANCEMENT ORGANIZERS



1012

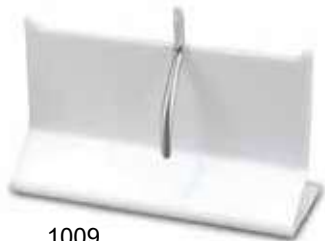

1009

1009:
UPRIGHT PLIER RACK

5"W x 9"L x 5 1/2"H

\$25.50/ea

1012:
PLIER AND INSTRUMENT ORGANIZER

3 1/8"W x 7 3/8"L x 5 1/8"H

\$43.20/ea



1001:
PLIER RACK (Drawer Type)
6 1/2"W x 9"L x 3 7/8"D
\$49.40/ea



1001-DB:
PLIER RACK
(Double Drawer)
6 3/16"W x 9 5/8"D x 2 1/2"H
\$49.40/ea



1002:
ARCH WIRE HOLDER
4"W x 11"L x 2"H
\$56.90/ea

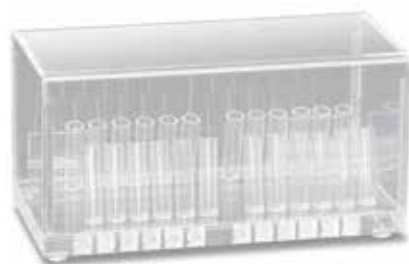

1002-CR:
ARCHWIRE HOLDER
w/COVER
7 3/4"W x 4 1/2"H x 4"D
\$66.70/ea



1003:
ARCH WIRE & INSTRUMENT HOLDER
6 5/8"W x 4 1/4"L x 4 1/4"H w/ 1/2" wide holding tubes
\$43.20/ea

1402MU-DD:
MULTIPURPOSE COMPOSITE SYRINGE ORGANIZER

DOUBLE DISPENSER
12 1/4"W x 3 3/4"H x 6 3/4"D
Holds 20

\$67.20



1403MU:
SMALL MULTIPURPOSE COMPOSITE SYRINGE ORGANIZER

SINGLE DISPENSER
8 1/8"W x 3 3/4"H x 6 3/4"D
Holds 14

\$54.90



1021:
ONE-WAY MICROAPPLICATOR DISPENSER

ONE-WAY
5"W x 3 1/2"H x 4"D

\$22.30



1402MU-SD:
MULTIPURPOSE COMPOSITE SYRINGE ORGANIZER

SINGLE DISPENSER
11 7/8"W x 3 3/4"H x 6 3/4"D
Holds 20

\$69.60



1024:
SMALL BUR ORGANIZER

SMALL
4"W x 2 1/4"H x 4 3/4"D
\$16.80



1022:
TWO-WAY MICROAPPLICATOR DISPENSER



TWO-WAY
6"W x 3 1/2"H x 5"D
\$31.70

PRACTICE ENHANCEMENT ORGANIZERS

**1023:
LARGE BUR ORGANIZER**

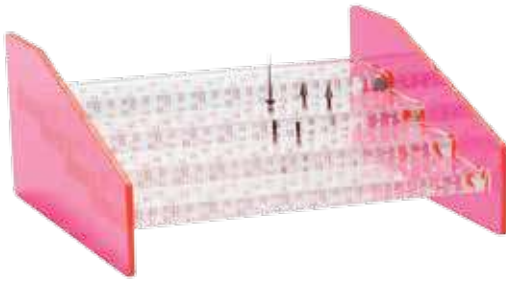

LARGE, 6"W x 3 1/3"H x 6"D
\$29.50

**1402-30:
LARGE PREMIUM COMPOSITE
SYRINGE ORGANIZER**



LARGE, 11 5/8"W x 3 3/4"H x 6 3/4"D
HOLD 30 **\$54.00**

**1403-14:
SMALL PREMIUM COMPOSITE
SYRINGE ORGANIZER**



SMALL, 7 3/4"W x 3 3/8"H x 5 3/4"D
HOLD 14 **\$32.80**

**1018:
COLOR-CODE RING DISPENSER**



6 1/3"W x 3/8"H x 4 5/8"D **\$26.30**



**1019:
ROUND SALIVA
EJECTOR
DISPENSER**

4" Dia x 7 5/8"H

\$29.40

**1020:
COVERED SALIVA EJECTOR
DISPENSER**



6 2/3"W x 4 3/4"H x 6"D **\$26.20**

**1209C:
LARGE CROSS HOLE COMPOSITE
MATERIAL ORGANIZER**

LARGE, 8 2/3"W x 2 2/3"H x 4 2/3"D
Holds 18 **\$29.50**



**1210C:
SMALL CROSS HOLE COMPOSITE
MATERIAL ORGANIZER**

SMALL, 4 2/3"W x 2 2/3"H x 4 2/3"D
Holds 12 **\$20.70**



**1210N:
SMALL NEW COMPOSITE
MATERIAL ORGANIZER**

SMALL, 4 2/3"W x 2 2/3"H x 4 2/3"D
Holds 12 **\$20.70**



**1209N:
LARGE NEW COMPOSITE
MATERIAL ORGANIZER**

LARGE, 8 2/3"W x 2 2/3"H x 4 2/3"D
Holds 24 **\$29.50**



**1403-6:
MINI PREMIUM COMPOSITE
SYRINGE ORGANIZER**

MINI, 4"W x 3 1/3"H x 5 3/4"D
HOLD 6 **\$23.00**



**1403A:
ADHESIVE SYRINGE ORGANIZER**

7 1/4"W x 4 1/3"H x 9 3/4"D
Holds 12 **\$35.60**





LARGE COMPOSITE MATERIAL ORGANIZER

1209-#:
8"W x 5 1/8"H
x 4 1/4"D
Color:
Blue, Yellow, Green,
Orange

\$28.50/ea



SMALL COMPOSITE MATERIAL ORGANIZER

1210-#:
4"W x 5 1/8"H
x 4 1/4"D
Color:
Blue, Yellow, Green,
Orange

\$22.50/ea



**BIB HOLDER/
LONG SIDE
LOADING**

1205-#:
8"W x 5 3/4"H
x 5 1/2"D
Color:
Blue, Yellow, Green,
Orange

\$26.80/ea



C-FOLD TOWEL ORGANIZER

1206-#:
11 7/8"W x 5 3/4"H
x 4 1/4"D
Color:
Blue, Yellow, Green,
Orange

\$26.70/ea



**EARLOOP
FACE MASK
ORGANIZER**

1212-#:
8"W x 5 1/4"H
x 4 3/4"D
Color:
Blue, Yellow,
Green, Orange

\$27.80/ea



**GLOVE BOX
HOLDER**

1400-#:
5 3/4"W x 10"H
x 3 3/4"D
Color:
Blue, Yellow,
Green, Orange

\$26.70/ea



NEW ROUND PLIER RACK

1004N:
4"Dia. x 5 1/2"Dia. Base x 4 1/4"H
Color: Blue, Yellow, Green, Orange
\$26.70/ea



NEW UPRIGHT PLIER RACK

1009N:
12"W x 5 1/2"H x 4"D
Color: Blue, Yellow, Green, Orange
\$28.50/ea



NEW SINGLE STRAIGHT PLIER RACK

1011N:
8 3/4"W x 4 1/2"H x 5 1/4"D
Color: Blue, Yellow, Green, Orange
\$38.20/ea

PRACTICE ENHANCEMENT ORGANIZERS



BULK ISOLATION STATION
1700:
 23"W x 17"H x 4½"D
\$189.00/ea



DOUBLE GLOVE ISOLATION STATION
1701:
 23"W x 21½"H x 4½"D
\$204.60/ea



ADA COMPLIANT PPE DISPENSER
1702:
 25"W x 22"H x 4½"D
\$224.80/ea



GLOVE, MASK & GOWN DISPENSER
1703:
 24"W x 17½"H x 4½"D
\$194.20/ea



GLOVE, MASK, TOWEL & BIB STATION
1704:
 18"W x 24"H x 5½"D
\$189.00/ea



TRIPLE GLOVE BOX DISPENSER with SHELVES
1705:
 22"W x 17½"H x 4½"D
\$163.50/ea



ACRYLIC ISOLATION DISPENSER
1706:
 20"W x 11"H x 5"D
\$102.20/ea



ACRYLIC DISINFECTING DISPENSER
1707:
 16"W x 17½"H x 4½"D
\$137.90/ea



905MS-L

905MS-S



MATERIAL SCRAPER

905MS-L:
 4"W x 5¼"L
 Large,
\$9.50/ea

905MS-S:
 1"W x 5¼"L
 Small,
\$6.70/ea



INSTRUMENT & SUPPLY HOLDER
1420:
 Small, Wall-Mount
 16"W x 5"H x 1 7/8"D
 \$56.20/ea



INSTRUMENT & SUPPLY HOLDER
1421:
 Large, Wall-Mount
 16"W x 7"H x 3 1/4"D
 \$66.50/ea



**UNIVERSAL HAND
 SANITIZER HOLDER**
1422:
 Wall-Mount
 5"W x 4 1/2"H x 5"D
 \$18.40/ea



SNEEZE GUARD



**SAFETY GLASSES
 HOLDER w/ Lid**
1423:
 10"W x 3 1/2"H x 8"D
 \$43.00/ea



WASTE BAG HOLDER
1424:
 6"W x 7"H x 3 1/2"D
 \$18.40/ea

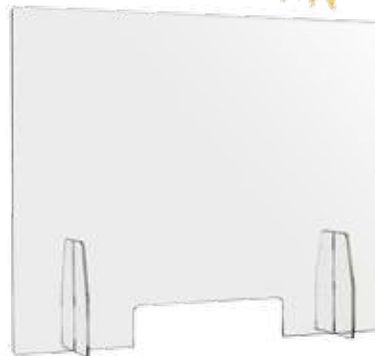

1419:
 Size- 30"W x 24"H
 \$93.30/ea



DR300: \$11.60/ea
#300 DRAWER TRAY
 16"L x 12 1/5"W x 1"H
 Colors: White, Blue, Beige and Gray



DR301: \$11.60/ea
#301 DRAWER TRAY
 16"L x 12 1/5"W x 1"H
 Colors: White, Blue, Beige and Gray



DR302: \$11.60/ea
#302 DRAWER TRAY
 16"L x 12 1/5"W x 1"H
 Colors: White, Blue, Beige and Gray



DR303: \$11.60/ea
#303 DRAWER TRAY
 16"L x 12 1/5"W x 1"H
 Colors: White, Blue, Beige and Gray



DR304: \$11.60/ea
#304 DRAWER TRAY
 16"L x 12 1/5"W x 1"H
 Colors: White, Blue, Beige and Gray



500TI: \$5.30/ea
TUB INSERT (DRAWER TRAY)
 11 3/8"L x 9 1/4"W x 1 1/8"H
 Colors: White, Blue, Beige and Gray



SDR-0707H:
DRAWER BOX
2 3/4" X 2 3/4" X 2 7/16"
\$0.85/ea

SDR-0714H:
DRAWER BOX
5 1/2" X 2 3/4" X 2 7/16"
\$1.50/ea

SDR-0926L:
DRAWER BOX
10 1/4" X 3 1/2" X 1 3/4"
\$3.75/ea



SDR-1414H:
DRAWER BOX
5 1/2" X 5 1/2" X 2 7/16"
\$2.50/ea

SDR-1813L:
DRAWER BOX
7" X 5 1/8" X 1 3/4"
\$2.55/ea

SDR-1826L:
DRAWER BOX
10 1/4" X 7" X 1 3/4"
\$3.30/ea



207CRD:
PULL STYLE COTTON ROLL DISPENSER
209CRD:
PUSH STYLE COTTON ROLL DISPENSER
Color: White, Blue, Purple and Beige
\$17.30/ea

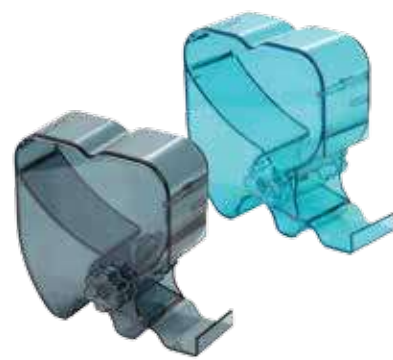

EURO COTTON ROLL DISPENSER
208CRD-2:
Transparent Blue
208CRD-9:
Smoky Gray
\$17.50/ea



MICRO APPLICATOR DISPENSER
600DS:
Color: White, Blue
\$13.90/ea



COTTON PELLETS DISPENSER
CBD-7:
Beige
\$15.00/ea



202IGL:
LARGE SILICONE INSTRUMENT GRIPS
 For #6 handle
202IGS:
SILICONE INSTRUMENT GRIPS
 For #2 & #4 handle
 Heat sterilize up to 375°F
 Color: Blue, Yellow, Green, Red, Purple, Mauve and Assorted

Single Color 20pcs/bag
\$24.60/bag
 Assorted Colors 24pcs/bag
\$28.60/bag



206IT:
SILICONE INSTRUMENTS TIES
 Color: Blue, Yellow, Green, Red, Purple
\$17.90/bag (6 Ties/Bag)

Anatomical

Both Cone Socket & Simple Stem available



Color:
 White, Blue,
 Yellow, Green,
 Red, Mauve,
 Purple

\$6.30/ea

SILICONE MIRROR HANDLES
 204MH: Cone Socket 204MHS: Simple Stem



MC4:
MIRROR COVER #4
 for #4 size mirror

MC5:
MIRROR COVER #5
 for #5 size mirror

Color:
 Blue, Yellow, Green,
 Red, Purple, Black
 and Assorted

size #5 size #4
\$20.30/bag of 12 pcs

Autoclavable



207CD:
HANDPIECE COLOR-CODE BANDS

24 pcs/bag Single Color
\$10.70/bag

35 pcs/bag Assorted Colors
\$12.90/bag

Color: White, Blue, Yellow,
 Green, Red, Mauve, Purple



202CD:
COLOR-CODE RINGS SILICONE
 60 pcs/box Single Color
\$8.20/box
 80 pcs/box Assorted Color
\$12.30/box

205CD:
LARGE-CODE RINGS SILICONE
 60 pcs/box Single Color
\$10.30/box
 80 pcs/box Assorted Color
\$14.40/box
 Color: White, Blue, Yellow,
 Black, Green, Red,
 Mauve, Purple

205CD

202CD



400CRD:
ROUND COTTON ROLL HOLDER

Color: White, Blue,
 Yellow and Beige

\$13.40/ea



4002SD:
2" x 2" SPONGE DISPENSER

In White, Blue, Beige
 and Mauve

\$12.90/ea

COLOR-CODE SET-UP PRODUCTS



BUR CADDY

400BC:
Autoclavable
capacity: 12
Reversible for FG & RA
burs, Adjustable 3
height levels

\$6.30/ea

Color:
White, Blue, Neon Blue,
Neon Yellow, Neon Green,
Neon Pink, Neon Purple,
Neon Tangerine, Black



FG BUR CADDY

400BB:
Autoclavable
capacity: 9

\$6.40/ea

Color:
White, Blue, Neon Blue,
Neon Yellow, Neon Green,
Neon Pink, Neon Purple,
Neon Tangerine, Black



ENDO CADDY EDC-#:

Autoclavable
capacity: 8
For Endo instruments

\$6.30/ea

Color:
White, Blue, Neon Blue,
Neon Yellow, Neon Green,
Neon Pink, Neon Purple,
Neon Tangerine, Black



FG BUR CADDY

400BB2:
Autoclavable
capacity: 16

\$7.40/ea

Color:
White, Blue, Neon Blue,
Neon Yellow, Neon Green,
Neon Pink, Neon Purple,
Neon Tangerine, Black



ENDO CADDY EDC2-#:

Autoclavable
capacity: 16
For Endo Instruments

\$7.50/ea

Color:
White, Blue, Neon Blue,
Neon Yellow, Neon Green,
Neon Pink, Neon Purple,
Neon Tangerine, Black



FG BUR CADDY

400BB3:
Autoclavable
capacity: 25

\$7.50/ea

Color:
White, Blue, Neon Blue,
Neon Yellow, Neon Green,
Neon Pink, Neon Purple,
Neon Tangerine, Black



203SC: INSTRUMENTS STERI CONTAINER

Color:
White, Vanilla, Blue,
Seagreen, Frame, Sand,
Mauve, Light Mauve, Lilac,
Black, Teal

\$6.30/ea



203ISC: INSTRUMENTS STERI CONTAINER

Color:
Blue, Yellow, Green,
Coral, Beige, Gray,
Neon Blue, Neon Yellow,
Neon Green, Neon Pink,
Neon Purple,
Neon Tangerine

\$6.30/ea

CABINET TRAYS

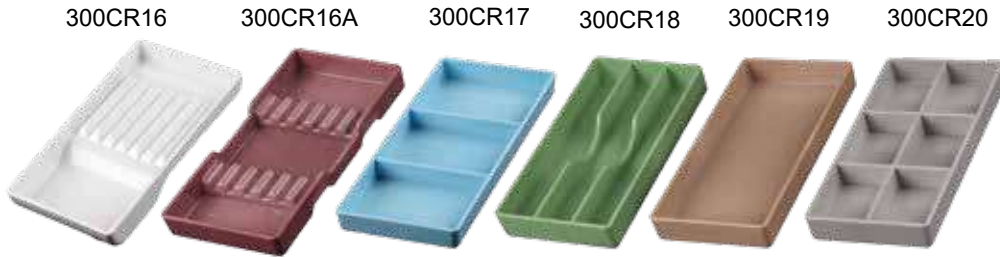

300CR16 Size 16 300CR16A Size 16A 300CR17 Size 17 **\$5.40/ea**
 300CR18 Size 18 300CR19 Size 19 300CR20 Size 20
 Color: 1-White, 2-Blue, 4-Green, 7-Beige, 9-Gray, 10-Mauve Autoclavable



CHROME TRAY RACK

for Benchtop Organization

300CR-TR
\$48.80/ea



Silicone



400ML: LARGE INSTRUMENT MAT
Capacity: 12, Dimensions 7 1/2" x 4" **\$6.30/ea**
400MS: SMALL INSTRUMENT MAT, Reversible
Capacity: 8 or 12, Dimensions 5 3/16" x 4 1/8"
Color: **\$5.30/ea**

400ML2: SILICONE LARGE INSTRUMENT MAT
Capacity: 12, Dimensions 7 1/2" x 4" **\$11.00/ea**
400MS2: SILICONE SMALL INSTRUMENT MAT
Capacity: 8 or 12, Dimensions 5 3/16" x 4 1/8"
Color: **\$8.80/ea**



LARGE BUR BLOCK w/LID
400LBB:
Ivory, 144FG/RA & 24FG
\$15.40/ea



LARGE BUR STATION w/LID
400LSS:
Ivory, 87FG/RA & 55FG
\$20.00/ea

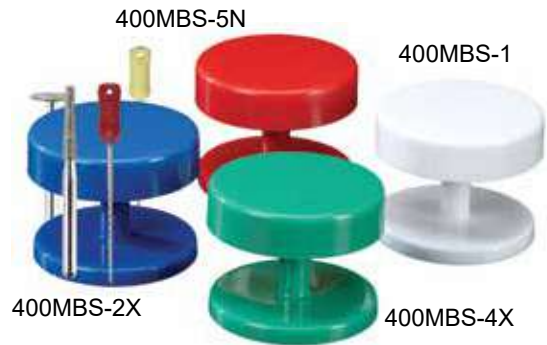

MAGNETIC BUR STAND
400MBS:
Color: White, Blue, Green and Red **\$11.00/ea**



400BR:
RECTANGULAR BUR BLOCK, MAGNETIC,
Capacity: 14, Dimensions (3" x 1 1/2" x 1/2") **\$7.30/ea**
400BS: SMALL ROUND BUR BLOCK, MAGNETIC,
Capacity: 7, Diameter 1 5/8" **\$6.30/ea**
400BL: LARGE ROUND BUR BLOCK, MAGNETIC,
Capacity: 28, Diameter 2 13/16"
Color: **\$7.30/ea**

400BR-COVR:
BUR BLOCK COVER FOR 400BR **\$5.20/ea**
400BS-COVR:
BUR BLOCK COVER FOR 400BS **\$4.10/ea**
400BL-COVR:
BUR BLOCK COVER FOR 400BL **\$5.20/ea**



ROUND 2-TIER BUR BLOCK
RBB01-1: Standard Lid, White **\$5.50/ea**
RBB01-2: Standard Lid, Blue

RBB03-1: Tall Lid, White
RBB03-2: Tall Lid, Blue **\$6.00/ea**

COLOR-CODE SET-UP PRODUCTS



300TRA:
TRAY RACK, CHROME for size A tray (stackable)
 15"W x 9 3/4"D x 14 1/8"H Capacity:8 **\$72.50/ea**

300TRB-C:
TRAY RACK, CHROME for size B tray (stackable)
 14 1/2"W x 9 3/4"D x 14 1/8"H Capacity:8 **\$69.30/ea**

300TRD:
TRAY RACK, CHROME for size D tray (stackable)
 14 1/2"W x 9 3/4"D x 14 1/8"H Capacity:8 **\$72.50/ea**

300TRE:
TRAY RACK, CHROME for size E tray (stackable)
 16 1/4"W x 9 3/4"D x 14 1/8"H Capacity:8 **\$72.60/ea**



TRAY & LID RACK, CHROME

300TRB-H:
 for size B tray & lid
 14 1/2"W x 9 3/4"D x 17 1/2"H
 Capacity:8
\$72.50/ea



MINI TRAY RACK, CHROME

300TRF:
 for size F tray
 10"W x 6 1/4"D x 13"H
 Capacity:6
\$47.70/ea



TRAY & LID RACK, CHROME

300TRF-H:
 for size F, lockable tray
 10"W x 6 1/4"D x 17"H
 Capacity:6
\$54.50/ea

500BRB



500BRB-H



OPERATION TUB NEON Colors:

- 500TBS-2:** Neon Blue
- 500TBS-3:** Neon Yellow
- 500TBS-4:** Neon Green
- 500TBS-6:** Neon Pink
- 500TBS-10:** Neon Purple
- 500TBS-12:** Neon Tangerine

PASTEL Colors:

- 500TBS-1PS:** Vanilla
- 500TBS-2PS:** Baby Blue
- 500TBS-4PS:** Seagreen
- 500TBS-7PS:** Sand
- 500TBS-10PL:** Light Mauve
- 500TBS-10PS:** Lilac



500TB: OPERATION TUB (9 3/8" x 11 1/2" x 2 5/8", w/ 3/4" Lip) **\$12.60/ea**

500TB-COVR: TUB LID **\$ 6.60/ea**

500TD-1: TUB DIVIDER, 6 pcs/set, White **\$ 5.30/set**

500TA-1: TUB ACCESSORY TRAY (7 7/8" x 3 7/8" x 1 1/8", White) **\$ 5.30/ea**

500TI : TUB INSERT TRAY (11 1/4" x 9" x 1 1/8") **\$ 5.30/ea**

500BRB: TUB RACK, Chrome (15"W x 9 3/4"D x 14 1/8"H, Capacity:4) **\$72.50/ea**

500BRB-H: TUB & LID RACK, Chrome (15"W x 10 3/8"D x 18 3/4"H, Capacity:4) **\$77.80/ea**

STANDARD Colors:

- 1-White
- 2-Blue
- 3-Yellow
- 4-Green
- 5-Flame
- 6-Coral
- 7-Beige
- 8-Gray
- 10-Mauve
- 11-Black
- 14-Teal

LOCKABLE TRAYS and COVERS



300BB2-COVR

300FM2-COVR

300BB2-COVR:
SIZE B Lockable TRAY Cover
\$8.70/ea

300FM2-COVR:
SIZE F Lockable TRAY Cover
\$6.40/ea



NEON & STANDARD COLORS

300BF2: LOCK FLAT TRAY SIZE B
(RITTER)
13 1/2" x 9 5/8" x 7/8"
\$8.70/ea

300BD2: LOCK DIVIDED TRAY SIZE B
(RITTER)
13 1/2" x 9 5/8" x 7/8"
\$9.70/ea

300FM2: LOCK FLAT TRAY SIZE F
(MINI)
9 5/8" x 6 5/8" x 7/8"
\$6.40/ea

400BQ2: SILICONE SQUARE BUR BLOCK
MAGNETIC
Capacity: 8, Dimension 1 9/16" x 1 9/16"
\$9.60/ea

400BL2: SILICONE LARGE ROUND BUR BLOCK
MAGNETIC
Capacity: 28, Diameter 2 13/16"
\$11.90/ea

400BS2: SILICONE SMALL ROUND BUR BLOCK
MAGNETIC
Capacity: 7, Diameter 1 5/8"
\$9.60/ea

400BR2: SILICONE RECTANGULAR BUR BLOCK
MAGNETIC
Capacity: 14, Dimension 3" x 1 1/2" x 1/2"
\$10.70/ea

400ML2: SILICONE LARGE INSTRUMENT MAT
Capacity: 12, Dimension 7 1/2" x 4"
\$11.00/ea

400MS2: SILICONE SMALL INSTRUMENT MAT
Capacity: 8 or 12,
Dimension 5 3/16" x 4 1/8"
\$8.80/ea



400BR-COVR:
BUR BLOCK COVER FOR 400BR & 400BR2 \$5.20/ea

400BS-COVR:
BUR BLOCK COVER FOR 400BS & 400BS2 \$4.10/ea

400BL-COVR:
BUR BLOCK COVER FOR 400BL & 400BL2 \$5.20/ea

400BQ-COVR:
BUR BLOCK COVER FOR 400BQ2 \$4.40/ea



Available in Standard & Neon Colors

1. WHITE	13. NEON BLUE
2. BLUE	14. NEON YELLOW
3. GREEN	15. NEON GREEN
4. BEIGE	16. NEON PINK
5. GRAY	17. NEON PURPLE
6. MAUVE	18. NEON TANGERINE

Colorful & Stackable

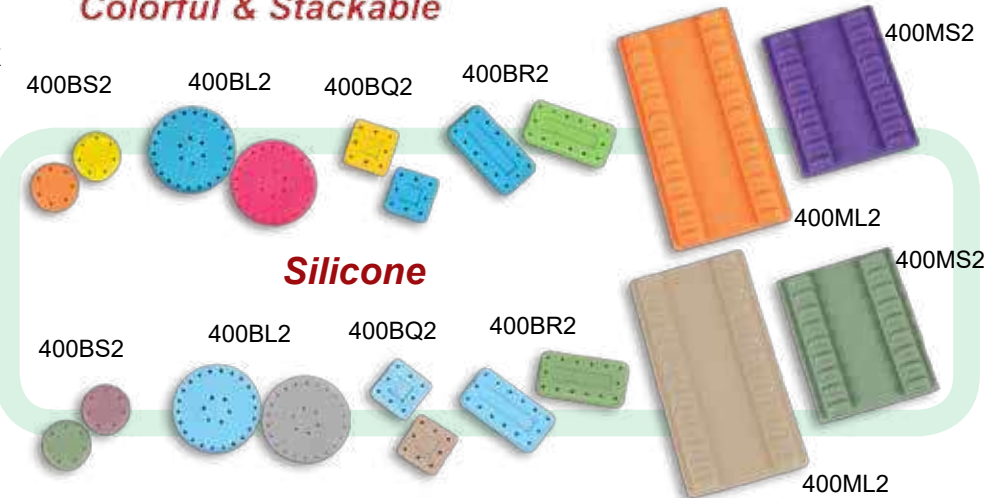

Silicone

COLOR-CODE SET-UP PRODUCTS

NEON COLORS



NEON & PASTEL COLORS

300BFS: FLAT TRAY SIZE B (RITTER)

13 1/2" x 9 5/8" x 7/8"

Color: (N) **\$7.30/ea**

300BDS: DIVIDED TRAY SIZE B (RITTER)

13 1/2" x 9 5/8" x 7/8"

Color: (N) **\$8.50/ea**

300FMS: FLAT TRAY SIZE F (MINI)

9 5/8" x 6 5/8" x 7/8"

Color: (N) **\$4.20/ea**

400BLS: LARGE ROUND BUR BLOCK

MAGNETIC

Capacity: 28, Diameter 2 13/16"

Color: (N) **\$7.30/ea**

400BSS: SMALL ROUND BUR BLOCK

MAGNETIC

Capacity: 7, Diameter 1 5/8"

Color: (N) **\$6.30/ea**

400BRS: RECTANGULAR BUR BLOCK

MAGNETIC

Capacity: 14, Dimension 3" x 1 1/2" x 1/2"

Color: (N) **\$7.30/ea**

400MLS: LARGE INSTRUMENT MAT

Capacity: 12, Dimension 7 1/2" x 4"

Color: (N) **\$6.30/ea**

400MSS: SMALL INSTRUMENT MAT

Capacity: 8 or 12,

Dimension 5 3/16" x 4 1/8"

Color: (N) **\$5.30/ea**

STANDARD COLORS

300BF: FLAT TRAY SIZE B (RITTER)

13 1/2" x 9 5/8" x 7/8"

Color: (S) **\$7.30/ea**

300BD: DIVIDED TRAY SIZE B (RITTER)

13 1/2" x 9 5/8" x 7/8"

Color: (S) **\$8.50/ea**

300FM: FLAT TRAY SIZE F (MINI)

9 5/8" x 6 5/8" x 7/8"

Color: (S) **\$4.20/ea**

400BL: LARGE ROUND BUR BLOCK

MAGNETIC

Capacity: 28, Diameter 2 13/16"

Color: (S) **\$7.30/ea**

400BS: SMALL ROUND BUR BLOCK

MAGNETIC

Capacity: 7, Diameter 1 5/8"

Color: (S) **\$6.30/ea**

400BR: RECTANGULAR BUR BLOCK

MAGNETIC

Capacity: 14, Dimension 3" x 1 1/2" x 1/2"

Color: (S) **\$7.30/ea**

400ML: LARGE INSTRUMENT MAT

Capacity: 12, Dimension 7 1/2" x 4"

Color: (S) **\$6.30/ea**

400MS: SMALL INSTRUMENT MAT

Capacity: 8 or 12, Dimension 5 3/16" x 4 1/8"

Color: (S) **\$5.30/ea**

PASTEL COLORS



STANDARD COLORS



300FM-COVR:
SIZE F TRAY LID
\$4.10/ea

300BB-COVR:
SIZE B TRAY LID
\$6.20/ea





FLAT TRAY

300EF:
FLAT TRAY SIZE E (Midwest)
15" x 10 1/2" x 7/8"
Color: S **\$7.30/ea**

300AF:
FLAT TRAY SIZE A (Chayes)
13 3/4" x 10 5/8" x 7/8"
Color: S **\$7.30/ea**



DIVIDED TRAY

300AD:
SIZE A (Chayes)
13 3/4" x 10 5/8" x 7/8"
Color: S **\$8.50/ea**

300ED:
SIZE E (Midwest)
15" x 10 1/2" x 7/8"
Color: S **\$8.50/ea**



FLAT TRAY

300DF:
SIZE D (A-Dec, Den-Tal-Ez)
12 3/8" x 7 3/4" x 3/4" Color: White & Blue **\$7.30/ea**



DISPOSABLE TRAY LINER

300DTL:
11" x 7"
Color: White
50pcs/box

\$15.10/box



TROPICAL TR8000:
100 pcs/bag **\$6.00/bag**

Colorful Saliva Ejector



SPECTRUM SP8000:
100 pcs/bag **\$6.00/bag**



FLEXJET™ SALIVA EJECTOR-SOFT

8000-CLB:
Clear with Blue Tip
8000-CL:
Clear with White Tip
8000-CL2:
Trans Blue with Blue Tip
8000-CL4:
Trans Green with Green Tip
8000-OP:
White with White Tip
\$4.80/bag

100 pcs/bag, 10 bag/box, 4 box/case



8000-CLM FLEXJET™ CLEAR MULTI-COLORED TIPS SALIVA EJECTORS

8000-OPM FLEXJET™ OPAQUE MULTI-COLORED TIPS SALIVA EJECTORS

\$4.80/bag

EVACUATION & SUCTION PRODUCTS

SILICONE • AUTOCLAVABLE



SBC: BIB CLIP \$5.00/ea
Color: Blue, Yellow, Green, Lavender and Peach
COMFORT DESIGN • PASTEL COLORS



204ABC: BIB CLIP \$4.30/ea
Color: White, Light Blue, Royal Blue, Yellow, Green, Red, Pink, Purple and Tangerine



BIB-CLP-1: White, **BIB-CLP-2:** Blue 24 pcs/box \$4.60/box
BIB-CLB-1

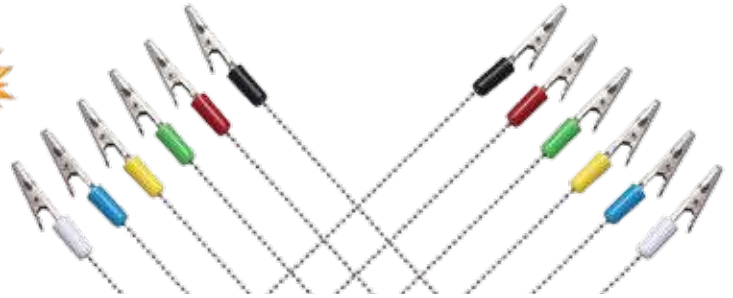

203BC: BIB CHAINS \$4.10/ea
Color: White, Blue, Yellow, Green, Red and Black



8008: HI-VAC™ 2 IN 1 ORAL EVACUATOR
(COMBO) Vented and Non Vented in One
Color: White, 100 pcs/bag, 10 bag/box, 4 box/case \$6.60/bag
8015: ORAJET™ ORAL EVACUATOR, Non-Vented Tip, Bendable
Color: White, 100 pcs/bag, 20 bag/case \$6.60/bag
8018: ORAVAC™ ORAL EVACUATOR, Vented Tip, Bendable
Color: White, 100 pcs/bag, 20 bag/case \$8.30/bag
8888: DUALVACTOR™ Vented and Non Vented in One, Bendable
Color: White, 100 pcs/bag, 20 bag/case \$7.40/bag
8048: TRK-O-VAC™ ORAL EVACUATOR, Retraction and Tongue Guard in One
Color: White, 100 pcs/bag, 20 bag/case \$12.90/bag
8048A: TRK-O-VAC™ ORAL EVACUATOR, Autoclavable to 275°F
Color: Blue, 25 pcs/bag, 40 bag/case \$12.90/bag



8020XLG: ORALSURGE-III™ SURGICAL ASPIRATOR TIP
Vented Tip
Color: Seablue, 25 pcs/bag, 120 bag/case, 3/8 Orifice \$8.70/bag
8020LG-4: ORALSURGE-II™ SURGICAL ASPIRATOR TIP
Color: Aquamarine, 25 pcs/bag, 120 bag/case, 1/4 Orifice \$7.30/bag
8020LG-1: ORALSURGE-II™ SURGICAL ASPIRATOR TIP
Color: White, 25 pcs/bag, 120 bag/case, 1/4 Orifice \$7.30/bag
8020: ORALSURGE™ SURGICAL ASPIRATOR TIP
Color: White, 25 pcs/bag, 120 bag/case, 1/8 Orifice \$7.30/bag
8020ST: ORALSURGE-ST™ SURGICAL ASPIRATOR TIP
Color: Blue, 25 pcs/bag, 120 bag/case, 1/16 Orifice \$9.40/bag



8111 FLEXFORM™ SALIVA EJECTORS

White with clear adapter
100 pcs/bag
w/ 5 adapters

\$10.00/bag

8020A: CHROMASURGE™ SURGICAL TIPS

Color: Assorted
100 pcs/bag
20 bag/case

\$21.10/bag



8018C SPECTRUM™ ORAL EVACUATOR

Vented tip, bendable
Color: Assorted 7 Neon colors
100 pcs/bag
20 bag/case
\$12.70/bag



8018P PASTEL™ ORAL EVACUATOR

Vented tip, bendable
Color: Assorted 6 Pastel colors,
100 pcs/bag, 20 bag/case
\$12.70/bag



8008C: HI-VAC™ MULTI COLORS ORAL EVACUATOR

\$7.60/bag of 100



8028: EUVAC™ UNIVERSAL SUCTION TIPS

Color: Blue, Green, Pink, Gray, Purple, Orange, Assorted

\$6.50/bag of 12

Autoclavable to 250°F



8068: EUVAC™ CHILD SUCTION TIPS

Color: Blue, Green, Pink, Gray, Purple, Orange, Assorted

\$6.50/bag of 12

Autoclavable to 250°F

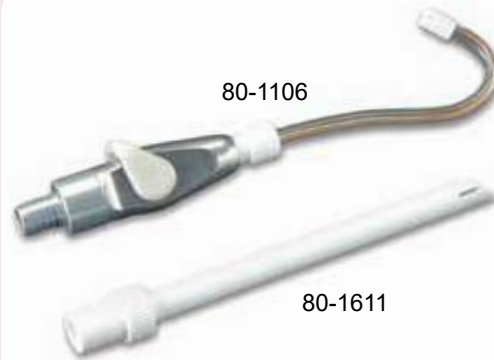

80-1106: SALIVA EJECTOR TO HVE ADAPTERS

Converts 11mm to 16mm
\$11.50/bag of 12

80-1611: HVE ADAPTERS

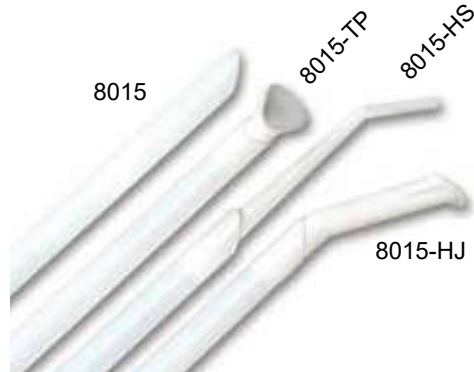

8015-TP: TIP INSERTS

8015-HS: SURGE INSERTS

8015-HJ: JET INSERTS

\$13.10/bag of 25

EVACUATION & SUCTION PRODUCTS

CLEANING BRUSH FOR ASPIRATOR TIP



8100HVE:
HVE TIPS
SCREENS
Clear,
100pcs/bag
\$13.60/bag



8015-AG:
HVE ANGLE
ADAPTORS
Clear,
50pcs/bag
\$4.30/bag



CBH-XL: X Large, 3/4" Dia. 8" Long
CBH-L: Large, 1/2" Dia. 12" Long
CBH-M: Medium, 1/4" Dia. 12" Long
CBH-S: Small, 1/8" Dia. 12" Long
CBH-XS: X Small, 3/32" Dia. 11" Long
CBH-SE: SE Cleaning, 3/8" Dia. 6 1/2" Long

\$3.20/ea

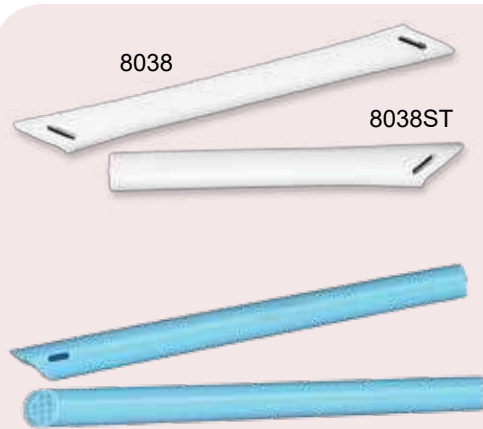

8038:
DUAL-VENTED TIP
5" Long
\$7.70/bag of 100

8038ST:
VENTED TIP
4" Long
\$7.70/bag of 100

8058:
SCREEN-VENT™
ORAL
EVACUATOR
Blue, 100 pcs/bag
20 bag/case
\$18.90/bag



8118 :
DRY ORAL CUP
\$8.40 /ea

8119 :
DRY ORAL CUP(II)
\$8.40 /ea

Autoclavable to 250°F

ACUTIPS™ DISPOSABLE AIR/WATER SYRINGE TIPS



TST-0: Clear / Clear
TST-1: White / Clear
TST-2: Blue / Clear
TST-3: Yellow / Clear
TST-4: Green / Clear
TST-10N: Purple / Clear
TST-A: Assorted Colors:
White, Blue, Yellow Green, Purple
\$28.50/bag of 250

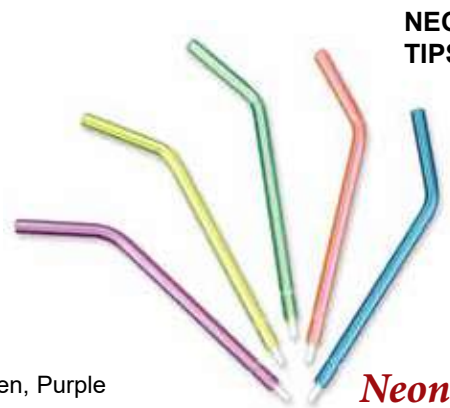

NEON COLOR TIPS

TST-NA:
bag of 250
\$28.50/bag

Neon Colors!



CLEAR COLOR TIPS

TST-SNTP:
bag of 250
\$24.20/bag

TST-SNTP(B):
box of 1500
\$130.70/box



METAL CORE TIPS

TST-MT:
bag of 150
\$24.20/bag

TST-MT(B):
box of 1600
\$235.00/box

Sani-Tip® Compatible

Metal Core!

Air Water Syringe Tips

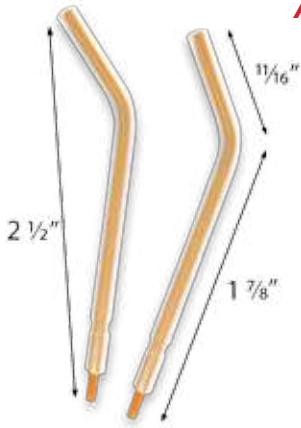

ACUTIPS™ SHORT

TST-SHOT:
bag of 250
\$27.70/bag



TST-SA:
bag of 250
\$28.50/bag

8000HV-L-7

8000HV-R-7

8000HV-L-11

8000HV-R-11

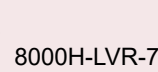

8000H-LVR-7



8000H-LVR-11

HVE Valves

8000HV-L-7: LEVER HVE VALVE / Beige	\$25.10/ea
8000HV-L-11: LEVER HVE VALVE / Black	\$25.10/ea
8000HV-R-7: ROTARY HVE VALVE / Beige	\$25.10/ea
8000HV-R-11: ROTARY HVE VALVE / Black	\$25.10/ea
8000H-LVR-7: HVE LEVER / Beige	\$5.30/ea
8000H-LVR-11: HVE LEVER / Black	\$5.30/ea

Saliva Ejector Valves

8000SE-L-7: LEVER SE VALVE / Beige	\$21.00/ea
8000SE-L-11: LEVER SE VALVE / Black	\$21.00/ea
8000SE-R-7: ROTARY SE VALVE / Beige	\$21.00/ea
8000SE-R-11: ROTARY SE VALVE / Black	\$21.00/ea
8000S-LVR-7: SE LEVER / Beige	\$4.20/ea
8000S-LVR-11: SE LEVER / Black	\$4.20/ea
8000SESN-7: SNAP-ON SE TIP / Beige	\$5.30/ea
8000SESN-11: SNAP-ON SE TIP / Black	\$5.30/ea
8100: SALIVA EJECTOR TRAPS / Clear 72 pcs / bag, One size fits all	\$11.40/bag



8000S-LVR-7



8000SESN-7



8100

8000S-LVR-11



8000SESN-11

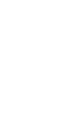

8000SE-L-7

8000SE-R-7

8000SE-L-11

8000SE-R-11

8234(5512)



8300(5510)



8156(5511)



8110(5504)



8212(6500)

8200(5506)



8234:Fits A-Dec 500 (Diameter 2 3/4")	8234-3(5512): DISPOSABLE TRAPS (Clear Color)	\$46.30 / box of 144
8300:Fits Sirona-C2,C3,C4,C6,C8,Pelton & Crane S1,S2 (Diameter 3")	8300-3(5510): DISPOSABLE TRAPS (Clear Color)	\$47.80 / box of 144
8156:Fits Kavo-The Environment (Diameter 1 15/16")	8156-3(5511): DISPOSABLE TRAPS (White Color)	\$48.00 / box of 144
8110:Fits Den-Tal-Ez with Wire Screen Filters (Diameter 1")	8110-3(5504): DISPOSABLE TRAPS (Clear Color)	\$47.80 / box of 144
8212:Fits Kavo-The Environment (Diameter 1 1/2")	8212-3(6500): DISPOSABLE STRAINERS (Clear Color)	\$45.40 / box of 144
8200:Fits Den-Tal-Ez with black plastic canisters (Diameter 2 3/4")	8200-3(5506): DISPOSABLE TRAPS (Clear Color)	\$47.70 / box of 144



G8178-3

B8218-3

Y8214-3

G8178-3: DISPOSABLE TRAPS (Green Color)	\$45.00/box of 144
B8218-3: DISPOSABLE TRAPS (Blue Color)	\$45.00/box of 144
Y8214-3: DISPOSABLE TRAPS (Yellow Color)	\$45.00/box of 144

EVACUATION & SUCTION PRODUCTS

Type A

VC-A



Bottom Port



Type A VACUUM CANISTER
VC-A:
 (2 1/8"), Beige
\$42.50/ea

CANISTER TWIST LID
VC-AC-LID:
 for A & C Type,
 Beige

\$7.30/ea

Type B

VC-B



Type B VACUUM CANISTER
VC-B: (1 7/8"), Beige
\$39.30/ea
HORIZONTAL MOUNT BRACKET,
VC-B-HB: Beige
\$6.30/ea
VERTICAL MOUNT BRACKET,
VC-B-VB: Beige
\$6.30/ea
CANISTER TWIST LID,
VC-B-LID:
 for B Type, Beige
\$7.30/ea

VC-B-VB



Vertical

VC-B-HB



Horizontal

Type C

VC-C



Side Port



Type C VACUUM CANISTER
VC-C:
 (2 1/8"), Beige
\$42.50/ea

CANISTER TWIST LID
VC-AC-LID:
 for A & C Type, Beige
\$7.30/ea



SE TUBING ADAPTER
VC-ADT:
 White
 Fits HVE Valve or Vacuum Canister HVE Port
\$5.30/ea
CANISTER PORTS PLUG
VC-PLG:
 Beige
 Fits HVE or SE Canister Port
\$4.20/ea
UNIVERSAL CANISTER LID O-RING
VC-RING:
\$4.20/ea



HD-HVE



HD-SE



HD-AW

HVE VALVE MOUNT HOLDER (7/8" Dia. Open), Beige, Black and Sterling
HD-HVE: \$6.30/ea
SE VALVE MOUNT HOLDER (5/8" Dia. Open), Beige, Black and Sterling
HD-SE: \$6.30/ea *Also for Extended HVE Valve
AW SYRINGE MOUNT HOLDER (5/8" Dia. Open), Beige, Black and Sterling
HD-AW: \$6.30/ea



OR-001: O-RING REPLACEMENT KIT
 Black, For CAVITRON
OR-002: O-RING REPLACEMENT KIT
 Green, For CAVITRON
\$13.50/bag
 (12 O-Rings & 1 Tool)

CC-IMP



IMPRESSION CARTRIDGE TRANSFER CONNECTORS
CC-IMP: Clear

\$16.60/bag of 5 pcs

CC-IMP2



VPS CARTRIDGE CONNECTORS
CC-IMP2: Blue
 for KETTENBACH



\$16.60/bag of 5 pcs

SAVE VPS Material

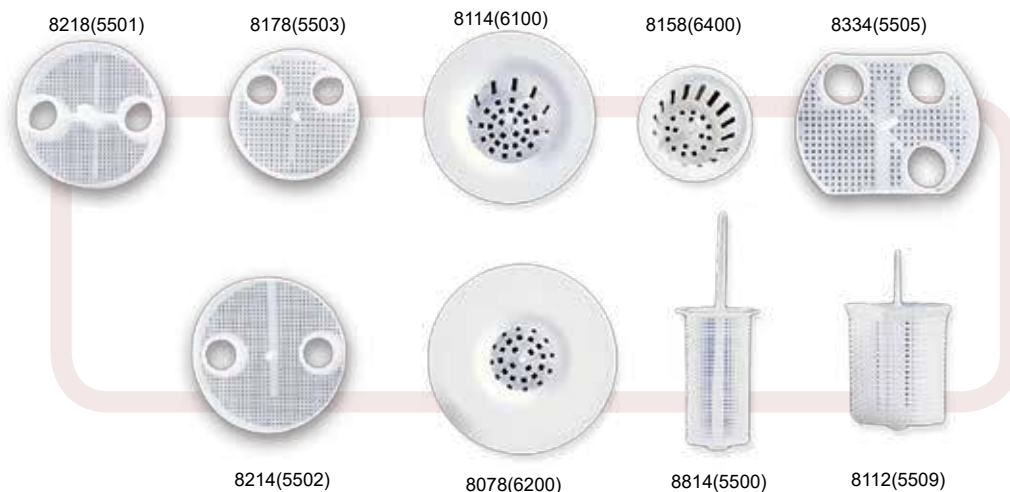

8218: Fits A-Dec Models with Plastic Canisters (Diameter 2 1/8")
8218-3(5501): DISPOSABLE TRAPS (Clear Color) **\$44.40/box** of 144

8178: Fits Belmont, Biotec, Chayes, Den-Tal-Ez, Dentech, Pelton & Crane, Proma and Others (Diameter 1 7/8")
8178-3(5503): DISPOSABLE TRAPS (Clear Color) **\$44.40/box** of 144

8114: Fits Most Cuspidor Bowls Including A-Dec, Ampco, Belmont, Dabi, Atlante, Dansereau, DCI, Den-Tal-Ez, Forest, Knight, Marus, MDT, Proma, Ritter, Schein
8114-3(6100): CUSPIDOR STRAINERS (Regular Size) **\$44.40/box** of 144

8158: Fits A-Dec Cascade and Performer Cuspidor Bowls (Diameter 1 5/8")
 8334: Fits Pelton & Crane Spirit with White Plastic Canisters (Diameter 2 3/4")
 8814: Fits A-Dec Cascade and Performer (Diameter 1 1/4")
 8214: Fits A-Dec Models with Metal Canisters (Diameter 2 1/4")
 8078: Fits Siemens, Planmeca, and many cuspidors with small openings
 8112: Fits DCI/ Belmont Reality Models, System 6000 Models (Diameter 1 1/2")

8158-3(6400): CUSPIDOR STRAINERS (White Color) **\$47.40/ box** of 144
8334-3(5505): DISPOSABLE TRAPS (Clear Color) **\$45.40/ box** of 144
8814-3(5500): DISPOSABLE TRAPS (Clear Color) **\$45.40/ box** of 144
8214-3(5502): DISPOSABLE TRAPS (Clear Color) **\$45.00/ box** of 144
8078-3(6200): CUSPIDORS STRAINERS (Small Size) **\$45.00/ box** of 144
8112-3(5509): DISPOSABLE TRAPS (Clear Color) **\$45.40/ box** of 144



DC8-2400: DISPOSABLE CANISTERS
 4 1/2"W x 5 1/8"H, Threads-Internal, 8 pcs/box
 Fits: Dentsply-MVS .75, 1.5, 2.0, 4.0 models made before 1991
\$93.90/box

DC8-2300: DISPOSABLE CANISTERS
 3 1/2"W x 4 3/8"H, Threads-Internal, 8 pcs/box
 Fits: Den-Tal-Ez dual models made after 1978, Dentsply made after 1991, Matrix 1000, 2000 and Drymax
\$90.80/box

DC8-2350: DISPOSABLE CANISTERS 3 1/2"W x 4 3/8"H, Threads-Internal, 8 pcs/box
 Fits: Apollo 2 hp, 3 hp single and tandem models, Air Techniques-1997 and later dual models, Vacudent-Workhorse dual, and newer Vacstar models. **NEW FINER MESH SCREEN \$90.80/box**

DC8-2200: DISPOSABLE CANISTERS 2 3/4"W x 3 5/8"H, Threads-Internal, 12 pcs/box
 Fits: Air Techniques-Vacstar Models, Apollo 1 hp, 1.5 Single: Tandem Models, 1, 2hp Den-Tal-EZ Single Models, Ohmeda-Matrix most models, Turbine Industries, Techwest-Whirl Vac Models, Vacudent-Workhorse Single, Midmark CV3R, plus other units **\$90.80/box**



HPB-4911 **PRESSURE WATER BOTTLE**

HPB-4910:
 750ML
 3 1/4" Dia x 10"H
\$10.80/ea

HPB-4911
HPB-4911:
 2 LITER
 3 1/2" Dia
 x 14 1/2"H
\$17.70/ea

60 PSI

Disposable Vacuum Traps



CR8178-3:
 Fit Ampco, Some pre-1998 Belmont, Biotec, Chayes, Dabi-Atlante, Dansereau, DCI, DentalEZ, Dentech, Forest, Knight, Pelton & Crane, Promo and other 1-7/8" Traps

CR8218-3:
 Fit Adec Plastic Traps, Belmont Evoque & Quolis units, Belmont BDS-0050 Vac Pacs and other 2-1/8" Traps

\$67.20/pack of 144

IMPRESSION PRODUCTS



904SA

903MS: MIXTIX™ MIXING SPATULAS
In White (100 pcs/bag) **\$8.40/bag**
904SA: NYLON SPATULA
Firm, Neutral **\$4.20/ea**
905SA-1: ALGINATE SPATULA
Soft, White **\$4.20/ea**



901DD:
DAPDISH™ DENTAL DAPPEN DISHES
Assorted in White, Blue, Yellow and Red (200 pcs/box) **\$12.80/box**
901DD(B):
DAPDISH™ DENTAL DAPPEN DISHES
Assorted in White, Blue, Yellow and Red (1000 pcs/box) **\$41.80/box**



902CF:
BU-UP™ CORE FORMS
100 pcs/box in S, M, L, XL
or Assorted Sizes
\$15.60/box



SDD-1:
STICKY DAPPEN DISHES
White, 100 pcs/bag
\$8.80/bag



904MBL



904MBM

905SA



904MBL: SPECTRUM FLOWBOWL™ MIXING BOWL 600cc, Large **\$7.40/ea**
904MBM: SPECTRUM FLOWBOWL™ MIXING BOWL 350cc, Medium **\$5.40/ea**
905SA: SPECTRUM ALGINATE SPATULA Soft Nylon
Color: White, Blue, Yellow, Green, Ruby Red, Purple, Pink and Orange **\$4.20/ea**



904MB-L

904MB-M

904MB-S

904MB-L: FLOWBOWL™ MIXING BOWLS/Large
600cc, Dark Green **\$7.40/ea**
904MB-M: FLOWBOWL™ MIXING BOWLS/Medium
350cc, Dark Green **\$5.40/ea**
904MB-S: FLOWBOWL™ MIXING BOWLS/Small
150cc, Dark Green **\$4.20/ea**

907DMB



907DMS



907DMB: DISPOSABLE MIXING BOWLS **\$8.50/bag of 12 pcs**
907DMS: DISPOSABLE MIXING SPATULAS **\$6.30/bag of 12 pcs**
Color: 1-White, 2N-Neon Blue, 3N-Neon Yellow, 4N-Neon Green, 6N-Neon Pink, 10N-Neon Purple, A-Assorted

906SALT

906SALT:
ERGONOMIC SPATULAS LEFT HANDED, 7 1/4"
Color: White, Blue
\$5.40/ea

906SAXL

906SAXL:
ERGONOMIC SPATULAS EXTRA LONG, 11"
Color: White, Blue
\$7.30/ea



906SA:
ERGONOMIC SPATULAS STANDARD, 7 1/4"
Color: White, Blue, Yellow, Pink, Gray, Lilac, Teal, Neon Green, Neon Pink, Neon Tangerine
\$4.30/ea



906SAL:
ERGONOMIC SPATULAS LONG, 8 7/8"
Color: White, Blue, Yellow, Pink, Gray, Lilac, Teal, Neon Green, Neon Pink, Neon Tangerine
\$5.40/ea





600B-R-400: MAXAPPLICATORSII™
Regular (100 Blue, 100 Green, 100 Purple, 100 Orange)
600B-F-400: MAXAPPLICATORSII™
Fine (200 Pink, 200 Yellow)
600B-SF-400: MAXAPPLICATORSII™
Super Fine (200 White), Ultra Fine (200 Black)
600B-A-400: MAXAPPLICATORSII™
Regular (100 Blue), Fine (100 Yellow)
Super Fine (100 White), Cylinder (100 Gray)



\$12.95/box of 400 pcs



INTRAORAL TIPS

IT8010: Yellow
IT8010-BK: Black
IT8030: Clear
IT8003: Clear
IT8005: Ribbon Tips, Clear
\$20.30/bag of 100 pcs



IT8007:
Elongation Tips, Clear
\$10.00/bag of 10 pcs



8080:
DISPOSABLE IMPRESSION SYRINGES
Clear, bendable tip,
50 set/box **\$11.60/box**

8090:
DISPOSABLE IMPRESSION SYRINGES
1 1/2", Longer Tip, Bendable
50 set/box **\$11.00/box**

DYNAMIC MIXING TIPS



IT8-7: RED, for 3M Penta 5:1
IT8-8: BLUE, for Dentsply DUOMIX
IT8-9: WHITE, for DMG MixStar
IT8-12Y: YELLOW, for Heraeus Kulzer, GC, Hugel, Muller-Omicron, Zhermack
IT8-15: BLUE, for Dentsply (old style machine)

\$34.00/bag of 50 pcs

IT8-12G: GRAY, for Zhermack MODULMIX 5:1
IT8-16: GREEN, for Kettenbach (old style machine)

\$38.00/bag of 50 pcs



HUB-FF:
Hub for Free-Flo syringe
\$3.10/ea



STP-FF:
Tip for Free-Flo syringe
Clear, 100pcs/bag
\$20.20/bag



HUB-GC:
Hub for GC syringe
\$3.10/ea

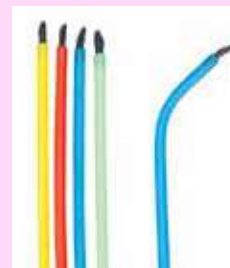

8101: 5 1/2" L BRUSH APPLICATORS
Colors:
Blue, Yellow, Green, Red and Assorted 144 pcs/box
\$16.20/box



MICRO APPLICATORS

8202-2: Blue **8202-3:** Yellow **8202-4:** Green
8202-5: Red **8202-10N:** Purple **8202-11:** Black
\$7.90/box of 144



Maxapplicators™

600-R-#: MAXMICRO™ APPLICATORS
600-F-#: MAXMICRO™ APPLICATORS
600-SF-1: MAXMICRO™ APPLICATORS
600-UF-11: MAXMICRO™ APPLICATORS
600-EX-11: MAXEXT™ MICRO APPLICATORS

Regular (Peach, Purple, Green, Blue)
Fine (Pink, Yellow)
Super Fine (White)
Ultra Fine (Black)
Extended (Black)

\$6.60/box of 100 pcs

Maxbrush™

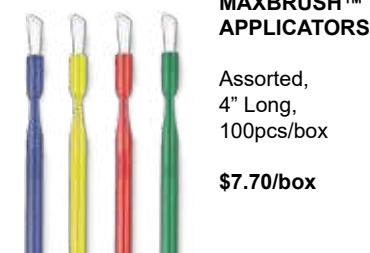

8101ST-A: MAXBRUSH™ APPLICATORS

Assorted,
4" Long,
100pcs/box
\$7.70/box

IMPRESSION PRODUCTS



MF-L:
LARGE MODEL FORMERS
 Blue, 3pcs Upper and 3 pcs Lower per Box **\$17.00/box**

MF-M:
MEDIUM MODEL FORMERS
 Green, 3pcs Upper and 3 pcs Lower per Box **\$13.90/box**

MF-S:
SMALL MODEL FORMERS
 Yellow, 3pcs Upper and 3 pcs Lower per Box **\$11.80/box**

MF-A:
MODEL FORMERS KIT
 6 pcs Assorted Sizes **\$13.90/box**



MD-001:
MODEL CARRIER SET
 1 Tray w/ 2 Foams
 300 sets/case **\$259.40/case**

MD-002:
FOAM for MODEL CARRIER
 Charcoal,
 1000 pcs/case **\$150.00/case**



8303-1:
STICKY™
APPLICATORS
 White,
\$14.10/box of 60



8404HND:
UNIVERSAL BRUSH HANDLE
 In Blue, White, Green,
 Red, Yellow **\$2.10/ea**

8404BRH:
BRUSH TIPS
 100 pcs/bag **\$4.90/bag**

8404KIT:
BRUSH & HANDLE MIX KIT
 100 Brush Tips and 5 Handles **\$6.40/box**



FT-L: DISPOSABLE DUAL FLUORIDE TRAYS
 Large, Blue, 100 pcs/bag

FT-M: DISPOSABLE DUAL FLUORIDE TRAYS
 Medium, White, 100 pcs/bag

FT-S: DISPOSABLE DUAL FLUORIDE TRAYS
 Small, Yellow, 100 pcs/bag

\$27.40/bag

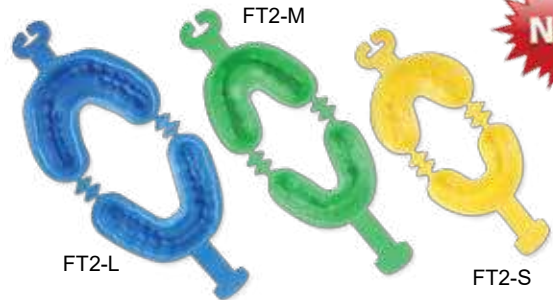

FT2-L: DISPOSABLE DUAL FLUORIDE TRAYS
 Large, Blue, 100 pcs/bag

FT2-M: DISPOSABLE DUAL FLUORIDE TRAYS
 Medium, Green, 100 pcs/bag

FT2-S: DISPOSABLE DUAL FLUORIDE TRAYS
 Small, Yellow, 100 pcs/bag

\$20.40/bag



FTS-L: DISPOSABLE SINGLE FLUORIDE TRAYS
 Large, Blue, Upper Large, White, Lower

FTS-M: DISPOSABLE SINGLE FLUORIDE TRAYS
 Medium, Green, Upper Medium, White, Lower

FTS-S: DISPOSABLE SINGLE FLUORIDE TRAYS
 Small, Yellow, Upper Small, White, Lower

\$11.30/bag of 100 (50 upper & 50 lower)

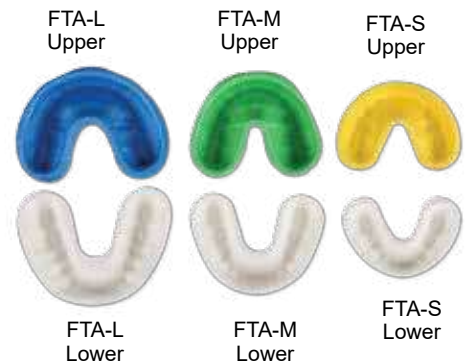

FTA-L: DISPOSABLE SINGLE FLUORIDE ARCHES
 Large, Blue, Upper Large, White, Lower

FTA-M: DISPOSABLE SINGLE FLUORIDE ARCHES
 Medium, Green, Upper Medium, White, Lower

FTA-S: DISPOSABLE SINGLE FLUORIDE ARCHES
 Small, Yellow, Upper Small, White, Lower

\$11.30/bag of 100 (50 upper & 50 lower)

NEW



BIO TRAYS

- BOIT-X1:** #X1 X1-UPPER
- BOIT-X2:** #X2 X2-LOWER
- BOIT-1:** #1 L-UPPER
- BOIT-2:** #2 L-LOWER
- BOIT-3:** #3 M-UPPER
- BOIT-4:** #4 M-LOWER
- BOIT--5:** #5 S-UPPER
- BOIT-6:** #6 S-LOWER
- BOIT-7:** #7 U/R L/L
- BOIT-8:** #8 U/L L/R
- BOIT-9:** #9 ANTERIOR
- BOIT-10:** #10 ANTERIOR-UPPER

12 pcs/bag **\$10.30/bag**

HEAT MOLDABLE & BIODEGRADABLE

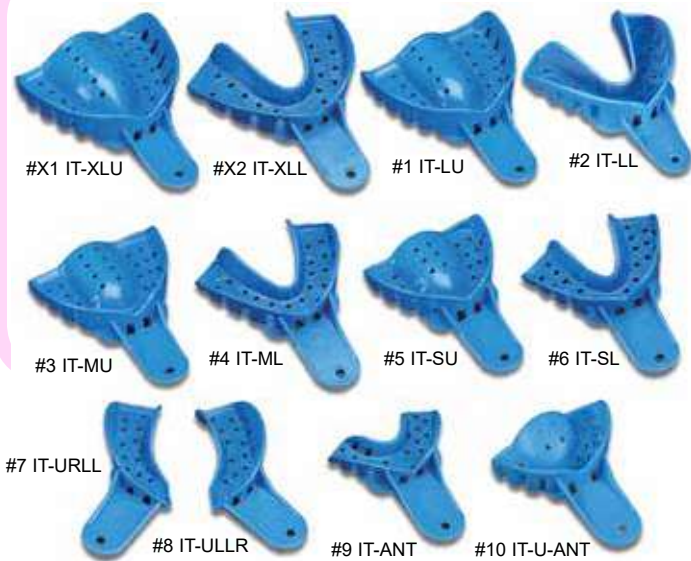

Excellent-Classic™ DISPOSABLE IMPRESSION TRAYS

- IT-XLU:** #X1 X-LARGE-UPPER
- IT-XLL:** #X2 X-LARGE-LOWER
- IT-LU:** #1 LARGE-UPPER
- IT-LL:** #2 LARGE-LOWER
- IT-MU:** #3 MEDIUM-UPPER
- IT-ML:** #4 MEDIUM-LOWER
- IT-SU:** #5 SMALL-UPPER
- IT-SL:** #6 SMALL-LOWER
- IT-URLL:** #7 UPPER-RIGHT/LOWER-LEFT
- IT-ULLR:** #8 UPPER-LEFT/LOWER-RIGHT
- IT-ANT:** #9 ANTERIOR
- IT-U-ANT:** #10 ANTERIOR-UPPER

12 pcs/bag Color:Royal Blue

\$6.40/bag

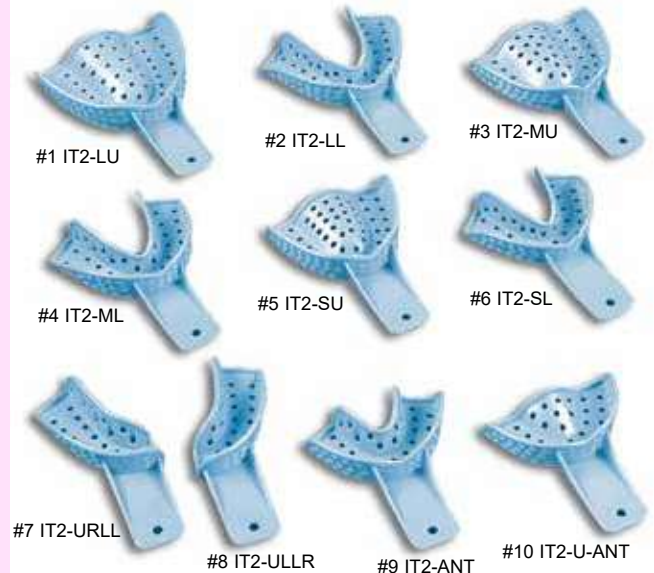

Excellent- II™ DISPOSABLE IMPRESSION TRAYS

- IT2-LU:** #1 LARGE-UPPER
- IT2-LL:** #2 LARGE-LOWER
- IT2-MU:** #3 MEDIUM-UPPER
- IT2-ML:** #4 MEDIUM-LOWER
- IT2-SU:** #5 SMALL-UPPER
- IT2-SL:** #6 SMALL-LOWER
- IT2-URLL:** #7 UPPER-RIGHT/LOWER-LEFT
- IT2-ULLR:** #8 UPPER-LEFT/LOWER-RIGHT
- IT2-ANT:** #9 ANTERIOR
- IT2-U-ANT:** #10 ANTERIOR-UPPER

12 pcs/bag Color:Baby Blue

\$6.40/bag

IMPRESSION PRODUCTS

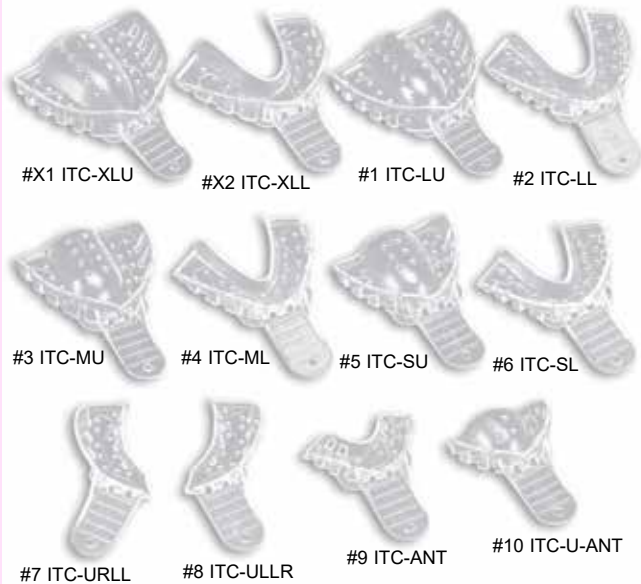

Excellent-Crystal™ DISPOSABLE IMPRESSION TRAYS
ITC-XLU: #1 X-LARGE-UPPER **ITC-XLL:** #2 X-LARGE-LOWER
ITC-LU: #1 LARGE-UPPER **ITC-LL:** #2 LARGE-LOWER
ITC-MU: #3 MEDIUM-UPPER **ITC-ML:** #4 MEDIUM-LOWER
ITC-SU: #5 SMALL-UPPER **ITC-SL:** #6 SMALL-LOWER
ITC-URLL: #7 UPPER-RIGHT/LOWER-LEFT
ITC-ULLR: #8 UPPER-LEFT/LOWER-RIGHT
ITC-ANT: #9 ANTERIOR **ITC-U-ANT:** #10 ANTERIOR-UPPER
 12 pcs/bag Color:Crystal **\$6.40/bag**



Excellent- DULOCK™ DISPOSABLE IMPRESSION TRAYS
IT3-LU: #1 LARGE-UPPER **IT3-LL:** #2 LARGE-LOWER
IT3-MU: #3 MEDIUM-UPPER **IT3-ML:** #4 MEDIUM-LOWER
IT3-SU: #5 SMALL-UPPER **IT3-SL:** #6 SMALL-LOWER
IT3-URLL: #7 UPPER-RIGHT/LOWER-LEFT
IT3-ULLR: #8 UPPER-LEFT/LOWER-RIGHT
IT3-ANT: #9 ANTERIOR **IT3-U-ANT:** #10 ANTERIOR/UPPER
 12 pcs/bag Color: Apple Green **\$6.40/bag**

Dual Lock



MINI IMPRESSION TRAYS
ITM-001:
 Yellow, 50 pcs/bag **\$33.60/bag**



EUROTRAY™ DISPOSABLE TRAYS
ITE-LU: #1 LARGE-UPPER **ITE-LL:** #2 LARGE-LOWER
ITE-MU: #3 MEDIUM-UPPER **ITE-ML:** #4 MEDIUM-LOWER
ITE-SU: #5 SMALL-UPPER **ITE-SL:** #6 SMALL-LOWER
ITE-URLL: #7 UPPER-RIGHT/LOWER-LEFT
ITE-ULLR: #8 UPPER-LEFT/LOWER-RIGHT
ITE-ANT: #9 ANTERIOR **ITE-U-ANT:** #10 ANTERIOR-UPPER
 12 pcs/bag **\$6.50/bag**



EXCELLENT™ AUTOCLAVABLE IMPRESSION TRAYS
ITA-LU: #1 LARGE-UPPER **ITA-LL:** #2 LARGE-LOWER
ITA-MU: #3 MEDIUM-UPPER **ITA-ML:** #4 MEDIUM-LOWER
ITA-SU: #5 SMALL-UPPER **ITA-SL:** #6 SMALL-LOWER
ITA-URLL: #7 UPPER-RIGHT/LOWER-LEFT
ITA-ULLR: #8 UPPER-LEFT/LOWER-RIGHT
ITA-ANT: #9 ANTERIOR **ITA-U-ANT:** #10 ANTERIOR-UPPER
 12 pcs/bag **\$9.70/bag**

ITO-1U #1 ITO-1L ITO-4U #4 ITO-4L
 ITO-2U #2 ITO-2L ITO-5U #5 ITO-5L
 ITO-3U #3 ITO-3L ITO-6U #6 ITO-6L

(CHILD SIZES) (ADULT SIZES)

Excellent-COLORS™ DISPOSABLE IMPRESSION TRAYS
 Single Size of 25 Trays **\$11.60** Assorted of 48 Trays **\$21.10**
 Single Size of 50 Trays **\$21.10** Assorted of 60 Trays **\$33.50**

ITT-5U ITT-4U ITT-3U ITT-2U ITT-1U
 ITT-5L ITT-4L ITT-3L ITT-2L ITT-1L

Pedo(Child) Adult

Excellent-LOCKS™ DISPOSABLE IMPRESSION TRAYS
 #Single Size of 50 Trays
 #Assorted of 50 Trays **\$23.20/bag**

NEW

#1 ITN-1 #3 ITN-3 #5 ITN-5
 #2 ITN-2 #4 ITN-4 #6 ITN-6
 #7 ITN-7 #8 ITN-8 #9 ITN-9 #10 ITN-10

EUROTRAY™ DISPOSABLE TRAYS

ITN-1: #1 LARGE-UPPER	ITN-2: #2 LARGE-LOWER
ITN-3: #3 MEDIUM-UPPER	ITN-4: #4 MEDIUM-LOWER
ITN-5: #5 SMALL-UPPER	ITN-6: #6 SMALL-LOWER
ITN-7: #7 UPPER-RIGHT/LOWER-LEFT	
ITN-ULLR: #8 UPPER-LEFT/LOWER-RIGHT	
ITN-9: #9 ANTERIOR	ITN-10: #10 ANTERIOR-UPPER

12 pcs/bag **\$7.30/bag**

Excellent™ BITE TRAYS

BT-ANT BT-FRH
 BT-POT BT-QRT BT-SPT

BT-ANT: ANTERIOR TRAYS 40 pcs/box
BT-POT: POSTERIOR TRAYS 50 pcs/box
BT-SPT: SIDELESS POSTERIOR TRAYS 50 pcs/box
BT-QRT: QUADRANT TRAYS 40 pcs/box

BT-FRH: FULL ARCH TRAYS 40 pcs/box
BT-ASS: ASSORTED TRAYS 40 pcs/box
 10 pcs/ea Anterior, Posterior, Sideless Posterior, Quadrant

\$16.50/box

Excellent™ COLORS BITE TRAYS

NEW

BTC-ANT BTC-WPT
 BTC-QRT BTC-POT BTC-SPT

BTC-ANT: ANTERIOR 40 pcs/box
BTC-POT: POSTERIOR 50 pcs/box
BTC-SPT: SIDELESS POSTERIOR 50 pcs/box
BTC-QRT: QUADRANT 40 pcs/box

BTC-WPT: WIDE POSTERIOR 40 pcs/box
BTC-ASS: ASSORTED 40 pcs/box

Rigid Rim **\$18.20/box**

AUTOCLAVABLE **NEW**

PR01-2: PROPHY PASTE RINGS
 Blue, 10 pcs/bag **\$6.80/bag**

PR01-10L: PROPHY PASTE RINGS
 Lavender, 10 pcs/bag **\$6.80/bag**

PR02: PROPHY PASTE RINGS
 Assorted, 100 pcs/bag **\$13.10/bag**

DISPOSABLE

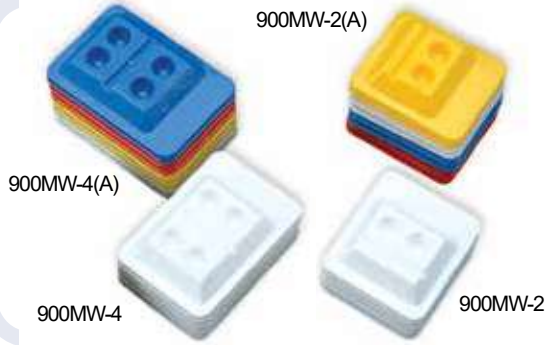

BONDWELL™ DISPOSABLE MIXING WELLS

- 900MW-4(A):** Assorted in White, Blue, Yellow and Red, 4-Well, 200 pcs/box **\$23.10/box**
- 900MW-4:** Color: White, 4-Well, 200 pcs/box **\$21.10/box**
- 900MW(B)-4:** Color: White, 4-Well, 500 pcs/box **\$45.40/box**
- 900MW-2(A):** Assorted in White, Blue, Yellow and Red, 2-Well, 200 pcs/box **\$21.10/box**
- 900MW-2:** Color: White, 2-Well, 200 pcs/box **\$18.00/box**
- 900MW(B)-2:** Color: White, 2-Well, 500 pcs/box **\$43.20/box**



BONDWELL-II DISPOSABLE MIXING WELLS

- 901MW-2:** 2-Well, White (200 pcs/box) **\$13.50/box**
- 901MW-4:** 4-Well, White (200 pcs/box) **\$15.80/box**



SILICONE MINI BOWLS

- 901MB-M:** Medium, 30 cc, 2 pcs/box **\$13.70/box**
- SILICONE MINI BOWLS**
- 901MB-S:** Small, 8 cc, 3 pcs/box **\$13.70/box**



TR-01: IMPRESSION TRAYS RACK

\$42.40/ea

TR-02: IMPRESSION TRAYS TOWER
2-Sided
\$19.40/ea



GLASS DAPPEN DISHES

- GDD-0:** Clear
- GDD-2:** Blue
- GDD-4:** Green
- GDD-12C:** Amber **\$2.20/ea**

Autoclavable up to 275°F

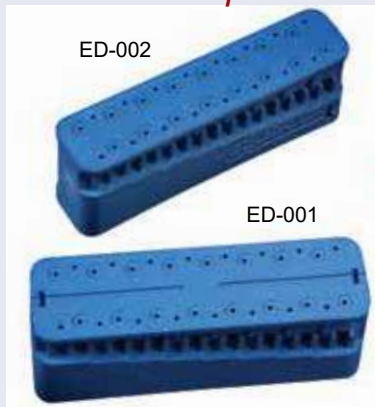

ENDO MEASURING BLOCK
(32 Depth Guides, Blue)

- ED-001:** 3 1/2"L x 1"W x 1 1/4"H
- ED-002:** 3 1/2"L x 3/4"W x 1 1/4"H **\$11.80/ea**

Autoclavable up to 275°F



ENDO RING RULER

- ED-000-#:**
- Color:** Blue, Red, Orange **\$4.30/ea**

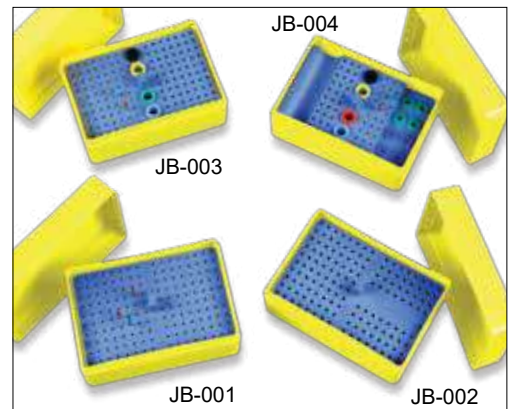

- JB-001:** JUMBO BUR BOX, 160 FG Bur **\$23.20/ea**
- JB-002:** JUMBO ENDO BOX, 144 Endo Instruments **\$23.20/ea**
- JB-003:** JUMBO BUR & ENDO BOX, 70 Burs, 70 Endo, 4 Vials **\$23.20/ea**
- JB-004:** JUMBO MULTI BOX, Multi-Function **\$23.20/ea**

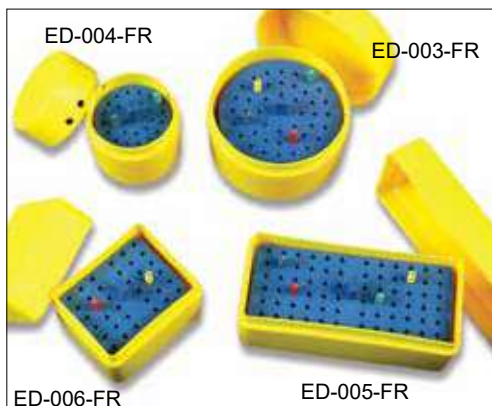

ENDO INSTRUMENTS BOX

- ED-003-FR:** LARGE ROUND ENDO BOX,
44 Endo instruments **\$15.10/ea**
- ED-004-FR:** SMALL ROUND ENDO BOX,
26 Endo instruments **\$11.80/ea**
- ED-005-FR:** RECTANGULAR ENDO BOX,
72 Endo instruments **\$16.10/ea**
- ED-006-FR:** SQUARE ENDO BOX,
36 Endo instruments **\$12.90/ea**

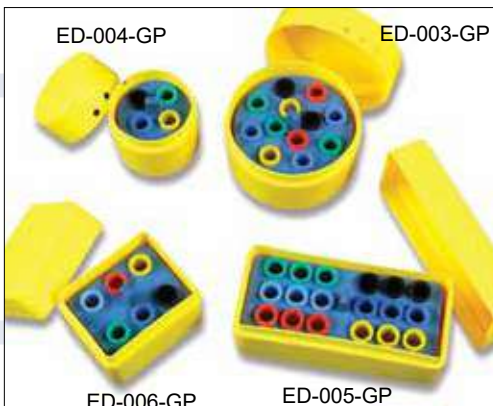

GUTTA PERCHA BOX

- ED-003-GP:** LARGE ROUND ENDO BOX,
12 Gutta Percha Vials **\$15.10/ea**
- ED-004-GP:** SMALL ROUND ENDO BOX,
4 Gutta Percha Vials **\$11.80/ea**
- ED-005-GP:** RECTANGULAR ENDO BOX,
18 Gutta Percha Vials **\$16.10/ea**
- ED-006-GP:** SQUARE ENDO BOX,
6 Gutta Percha Vials **\$12.90/ea**

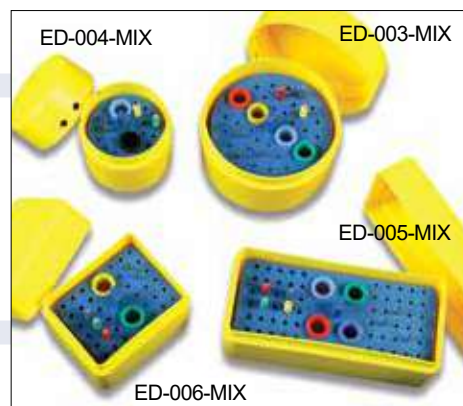

ENDO & BURS BOX

- ED-003-MIX:** LARGE ROUND ENDO BOX,
15 Endo, 15 Burs, 4 Vials **\$15.10/ea**
- ED-004-MIX:** SMALL ROUND ENDO BOX,
9 Endo, 9 Burs, 2 Vials **\$11.80/ea**
- ED-005-MIX:** RECTANGULAR ENDO BOX,
30 Endo, 30 Burs, 4 Vials **\$16.10/ea**
- ED-006-MIX:** SQUARE ENDO BOX,
18 Endo, 18 Burs, 2 Vials **\$12.90/ea**

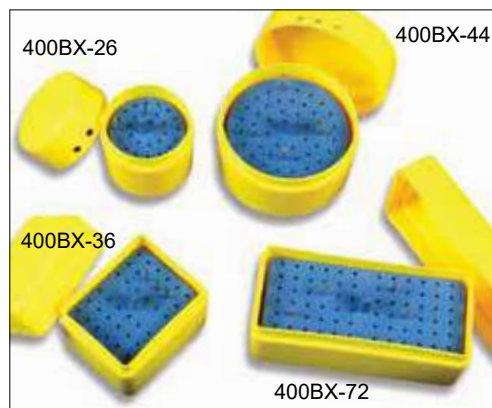

BURS BOX

- 400BX-26:** SMALL ROUND BUR BOX,
26 FG Burs **\$11.80/ea**
- 400BX-36:** SQUARE BUR BOX,
36 FG Burs **\$12.90/ea**
- 400BX-44:** LARGE ROUND BUR BOX,
44 FG Burs **\$15.10/ea**
- 400BX-72:** RECTANGULAR BUR BOX,
72 FG Burs **\$16.510/ea**

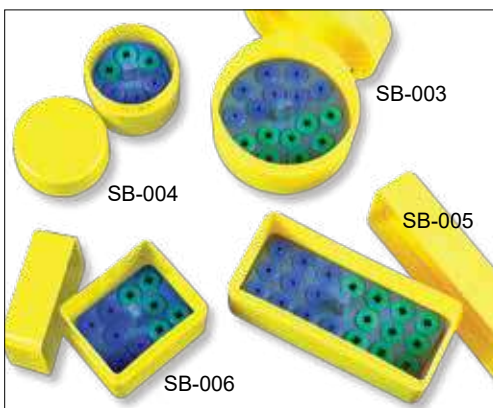

- SB-003:** LARGE ROUND STERI BOX,
Capacity: 16 **\$15.10/ea**
- SB-004:** SMALL ROUND STERI BOX,
Capacity: 6 **\$11.80/ea**
- SB-005:** RECTANGULAR STERI BOX,
Capacity: 20 **\$16.10/ea**
- SB-006:** SQUARE STERI BOX,
Capacity: 10 **\$12.90/ea**

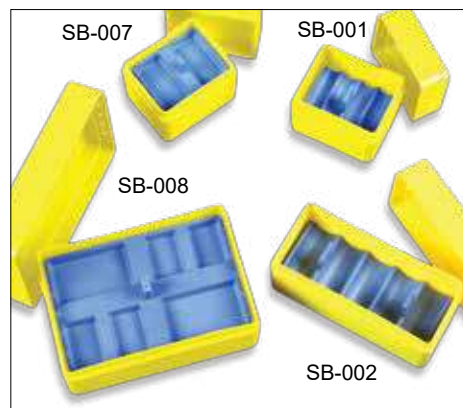

- SB-001:** SQUARE MULTI STERI BOX,
4 Small Sections **\$12.90/ea**
- SB-002:** RECTANGULAR MULTI STERI BOX,
5 Large Sections **\$16.10/ea**
- SB-007:** SQUARE MULTI STERI BOX,
2 Small Sections **\$12.90/ea**
- SB-008:** JUMBO MULTI STERI BOX,
5 Large, 4 Small Sections **\$22.80/ea**

ENDO MICRO ASPIRATORS





- MA-01:** UNTIPPED, HVELUER ADAPTOR:
\$16.80/bag of 25pcs
- MA-18:** TIPPED, 18GAUGE(Pink):
\$19.90/bag of 25pcs
- MA-20:** TIPPED, 20GAUGE(Yellow):
\$19.90/bag of 25pcs
- MA-25:** TIPPED, 25GAUGE(Blue):
\$19.90/bag of 25pcs





- BNT-18:** BENT NEEDLE TIPS-18ga., Pink
- BNT-20B:** BENT NEEDLE TIPS-20ga., Black
- BNT-20Y:** BENT NEEDLE TIPS-20ga., Yellow
- BNT-22:** BENT NEEDLE TIPS-22ga., Gray
- BNT-25:** BENT NEEDLE TIPS-25ga., Blue
- BNT-27:** BENT NEEDLE TIPS-27ga., Black
\$7.40/bag of 100 pcs
- BLT-100:** BENT LUER-LOCK TIPS Black
\$14.40/bag of 100 pcs

ENDODONTIC PRODUCTS



IRRIGATION TIPS

MONOVAC™	PROBEVAC™	DUALVAC™
 <p>INT-M23: 23ga, Blue</p> <p>INT-M27: 27ga, Yellow</p> <p>INT-M30: 30ga, Purple</p> <p>\$14.60 box of 100</p>	 <p>INT-P23: 23ga, Blue</p> <p>INT-P27: 27ga, Yellow</p> <p>INT-P30: 30ga, Purple</p> <p>\$18.00 box of 100</p>	 <p>INT2-P23: 23ga, Blue</p> <p>INT2-P27: 27ga, Yellow</p> <p>INT2-P30: 30ga, Purple</p> <p>\$21.40 box of 100</p>
Comparable to Monoject® style	Comparable to Max-I-Probe™ style	Double-Sided Vents





IRRIGATION PRE-TIPPED 3cc SYRINGES

MONOVAC™	PROBEVAC™
 <p>INT-MPT0323 : 23ga, Blue \$24.30/box of 100</p> <p>INT-MPT0327 : 27ga, Yellow \$24.30/box of 100</p> <p>INT-MPT0330 : 30ga, Purple \$24.30/box of 100</p>	 <p>INT-PPT0323 : 23ga, Blue \$28.50/box of 100</p> <p>INT-PPT0327 : 27ga, Yellow \$28.50/box of 100</p> <p>INT-PPT0330 : 30ga, Purple \$28.50/box of 100</p>

EO STERILE IRRIGATION PRE-TIPPED 3cc SYRINGES

 <p>INTS-MPT0323 : 23ga, Blue \$24.70/box of 100</p> <p>INTS-MPT0327 : 27ga, Yellow \$24.70/box of 100</p> <p>INTS-MPT0330 : 30ga, Purple \$24.70/box of 100</p>	 <p>INTS-PPT0323 : 23ga, Blue \$29.00/box of 100</p> <p>INTS-PPT0327 : 27ga, Yellow \$29.00/box of 100</p> <p>INTS-PPT0330 : 30ga, Purple \$29.00/box of 100</p>
--------------------------------------------------------------------------------------------------------------------------------------------------------------------------------------------------------------------------------------------------------------------------------------------------------------	---------------------------------------------------------------------------------------------------------------------------------------------------------------------------------------------------------------------------------------------------------------------------------------------------------------

LUER LOCK & UTILITY SYRINGES - Disposable, Non-sterile

 <p>LL12 : 12cc LUER LOCK SYRINGES \$15.50/box of 100</p>	 <p>LL03 : 3cc LUER LOCK SYRINGES \$ 8.80/box of 100</p>
 <p>LL06 : 6cc LUER LOCK SYRINGES \$ 9.80/box of 100</p>	 <p>LL-UT : 12cc UTILITY SYRINGES \$21.60/box of 50</p>
 <p>LL01 : 1cc LUER LOCK SYRINGES \$14.90/box of 100</p>	 <p>LL01B : 1cc LUER LOCK BLACK SYRINGES \$14.80/box of 100</p>

NEW

**EF12-9X
SQUARE ENDO FOAM INSERTS**
DARK GRAY, 48 PCS/BAG
\$13.70/bag



**EF13-9X
RECTANGULAR ENDO FOAM INSERTS**
DARK GRAY, 48 PCS/BAG
\$13.70/bag



**400ES:
ENDO CLEAN STAND**
White, Blue, Black,
Neon Blue, Neon Purple,
Neon Tangerine
Autoclavable
\$9.50/ea



**EFI-1:
ENDO FOAM
INSERTS**
Disposable, White
48 pcs/bag **\$13.90/bag**



**EFI(R)-2
ROUND ENDO
FOAM**
Disposable, Blue
48 pcs/bag
\$13.90/bag

IMPLANT IRRIGATION SET

NEW



IIT-BIENAIR:
COMPATIBLE with:
BIEN AIR iCHIROPRO/
CHIROPRO Units
\$68.00 bag/10 sets



IIT-KAVO-T:
COMPATIBLE with:
KAVO EXPERTSurg LUX/
SMARTSurg LUX/
MASTERSurg LUX Wireless/
ELITESurg & ELITESurg
Pro Units
\$89.80 bag/20 sets



IIT-U1:
COMPATIBLE with:
KAVO INTRASurg 300/
300 Plus, NOUVAG,
ANTHOGYR, BIEN AIR
CHIROPRO 980,
EIGHTEETH Units
\$89.80 bag/20 sets



IIT-U2:
COMPATIBLE with:
W&H Implantmed, NOBEL BIOCARE 80/Osseo 100/200/Osseocare,
FRIADENT Frios S/Si, 3i Surgical, STRAUMANN, ZIMMER, LIFECORE,
INNOVA, ELCOMED Units
\$90.70 bag/20 sets



IIT-U3:
COMPATIBLE with:
NSK Surgic Pro/Surgic Pro Led/Surgic XT/Surgic XT Plus/ VarioSurgic,
BIOMET 3i Osseocision, KYOCERA Implantor Neo, ASEPTICO AUE
6000/7000 Units
\$90.70 bag/20 sets



IIT-U4:
COMPATIBLE with:
W&H Elcomed/
Implantmed/Piezomed,
NSK, COXO,
WOOD PECKER,
SAESHIN, SAEYANG,
DENTIUM
\$89.80 bag/20 sets

UVEX SAFETY EYEWEAR

Made in USA



ASTRO-SPEC 3000®
S135C:
 Black/Clear \$19.50/ea

S0112C:
ASTRO-SPEC 2001®
 OTG CLEAR LENS
 \$15.00/ea

**18" SAFETY GLASSES
 NECK STRAP**



205GC
 Color: White, Purple, Royal Blue,
 Yellow, Red, and Pink.
 \$4.00/ea

AUTOCLAVABLE

**Hydro Shield™
 ANTI-FOG**



GENESIS®
S3200HS:
 Black/Clear \$19.50/ea



**7006:
 DISPOSABLE
 EYEGLASS
 SIDE SHIELDS**
 One Size Fits All
 250 pcs/box
 \$21.00/box



PLASDENT SAFETY EYEWEAR



P001

**P001-0:
 CLEAR SAFETY
 GLASSES**
 Anti-Fog & Scratch
 \$4.60/ea

**P001-12:
 ORANGE UV
 SAFETY GLASSES**
 Anti-Fog & Scratch
 \$4.60/ea



P003

**P003-2:
 CLEAR LENS BLUE
 FRAME SAFETY
 GLASSES**
 Anti-Fog & Scratch
 \$4.90/ea

**P003-11:
 CLEAR LENS BLACK
 FRAME SAFETY
 GLASSES**
 Anti-Fog & Scratch
 \$4.90/ea



P005

**P005-2:
 GRAY LENS BLUE
 FRAME SAFETY
 GLASSES**
 Anti-Fog & Scratch
 \$5.40/ea

**P005-11:
 GRAY LENS BLACK
 FRAME SAFETY
 GLASSES**
 Anti-Fog & Scratch
 \$5.40/ea



P008A

**P008A:
 CLEAR SAFETY
 GOGGLES**
 Anti-Fog & Scratch
 \$4.60/ea





**7005:
DISPOSABLE
FACE SHIELDS**

13"W x 8"L
24 pcs/box

\$39.70/box

*Wider, longer,
thicker and safer*



**7007:
DISPOSABLE FACE
SHIELDS**

11"W x 7½"L
1 Frame + 10 Visors

\$13.00/box



**7008:
DISPOSABLE FACE SHIELDS**

9"W x 7¾"L
1 Frame + 12 Visors

\$12.20/box



**20045
DENTAL APPLIANCE CLEANSER**
Mint Flavor
Box of 24 pcs \$2.20/box



**ARH2020:
ARCH2020™ RETAINER BOX**
Color:1,2,3N,4X,5N,6X,10N, Assorted
12 pcs/box

\$8.90/box



200TRD: PRO RETAINER BOX
Color: Assorted in 6 colors (2X, 3X, 4X, 5X, 6X, 7X)
12 pcs/box \$9.50/box



GT2002: GLITTER™ PREMIUM RETAINER BOX
For Retainer, Splint, and Night Guard 12 pcs/box \$9.50/box
GT2005: GLITTER™ PREMIUM DEEP DISH BOX
For Bigger Dental Appliance 12 pcs/box \$10.50/box
Color:2C,3C,4C,5C,10C,12C,Assorted

Tropical Color



TC2002: TROPICAL RETAINER BOX

Tropical Color:
2TC,3C,4TC,6TC, 10C,12C and Assorted
12 pcs/box

\$9.50/box

Liteflavor Color



TC2002: TROPICAL RETAINER BOX

Liteflavor Color:
2D,3D,4D,6D,10D,12D and Assorted
12 pcs/box

\$9.50/box



*with
Rinsing Basket*

DCH2000: DENTURE CAREBATH

Color: 1, 2D, 3D, 4D, 6D, 10D, Assorted
12 pcs/box

\$21.30/box



200BTH-PSA:

PASTEL™ DENTURE BOX

Color: Assorted in 1PS, 2PS, 4PS, 7PS, 10PL, 10PS
12 pcs/box

\$11.70/box



200PBH:

PROBATH™ DENTURE BOX

Color:1P,2P,3P,4P,5N,10P, Assorted PA
12 pcs/box

\$11.70/box



200BTH:

CHROMA™ DENTURE BOX

Color:2X,3X,4X,5X,5P,7X, Chroma Assorted XA
12 pcs/box

\$11.70/box



CR2300(B): DEEP DISH CONTAINER BOX

Color:0,2,Bulk 300 pcs/case **\$251.40/case**

200BTH: DENTURE BOX

Color:1,2,3,4,6,10, Assorted 12 pcs/box **\$11.70/box**

200BTH(D): DENTURE BOX/Bulk

Color:1,2,3,4,6,10 200 pcs/case **\$203.10/case**

200FI-2: FOAM INSERT FOR DENTURE BOX

1000 pcs/case **\$90.80/case**

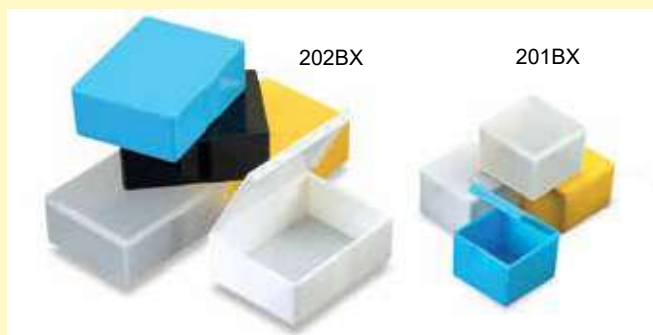

201BX:

DENTAL 1" BOX Color:0,1,2N,3N 1000 pcs/case **\$96.20/case**

202BX:

DENTAL 2" BOX Color:0,1,2N,3N,11 500 pcs/case **\$78.10/case**

DENTAL & LABORATORY APPLIANCE BOXES



200DB

200RT

200MN

200DB:

DEEP DISH RETAINER BOX

Color: 1,2N,3N,4N,5N,6N,7,9,10N,11,12, Assorted
12 pcs/box **\$10.50/box**

200RT:

STANDARD RETAINER BOX

Color: 1,2N,3N,4N,5N,6N,7,9,10N,11,12, Assorted
12 pcs/box **\$9.50/box**

200MN:

MINI DENTAL APPLIANCE BOX

Color: 1,2N,3N,4N,5N,6N,10N,11,12, Assorted
12 pcs/box **\$6.40/box**



200DB:

LITEFLAVOR™ DEEP DISH RETAINER BOX

Color: 2D,3D,4D,6D,10D,12D,TJA Assorted
12 pcs/box **\$10.50/box**



200RT:

LITEFLAVOR™ STANDARD RETAINER BOX

Color: 2D,3D,4D,6D,10D,12D,TJA Assorted
12 pcs/box **\$9.50/box**



CR2000:

CHROMA™ RETAINER BOX

Color: 1,2X,3X,4X,5X,6X,7X,8X,9X,10X, Assorted
12 pcs/box **\$9.50/box**



200-IBX:

I-BOX DENTAL APPLIANCE

Color: 2C,3C,4C,5C,6C,10C,12C, Assorted
12 pcs/box **\$7.40/box**



200RT-PSA: PASTEL™ STANDARD RETAINER BOX

Color: Assorted in 1PS, 2PS, 4PS, 7PS, 10PL, 10PS
12 pcs/box **\$9.50/box**



ER006:

EURO PREMIUM DENTURE BATH

Color: 1, 2, 4, 6, 10,11 and A-Assorted
12 pcs/bag **\$15.70/bag**



ER005-A:

MILK TOOTH BOX with String

Color: A-Assorted 5 Colors
50 pcs/bag **\$15.90/bag**

DENTAL & LABORATORY APPLIANCE BOXES & PRODUCTS



ER001:
EURO DENTURE CARE BATH
 Color: 1, 2, 4, 6, 10, 11 and A-Assorted
 12 pcs/bag **\$15.60/bag**



ER002:
HORSESHOE CURVE DENTURE BOX
 Color: 1, 2, 4, 6, 10, 11 and A-Assorted
 12 pcs/bag **\$11.00/bag**



ER003:
EURO DEEP DISH BOX
 Color: 1, 2, 4, 6, 10, 11 and A-Assorted
 12 pcs/bag **\$10.90/bag**



ER004:
EURO RETAINER BOX
 Color: 1, 2, 4, 6, 10, 11 and A-Assorted
 12 pcs/bag **\$8.80/bag**



- 209PLP: PRO LAB PAN**, 8 5/8" x 8 5/8" x 2 3/8" Deep
 Color: 1, 2, 3, 4X, 5N, 5P, 6, 6N, 6(O), 7, 10N, 11, 12, 14 **\$6.30/ea**
- 205LP: LAB PAN**, 7 3/8" x 4 5/8" x 2 3/8" Deep
 Color: 1, 2, 3, 5P, 6N, 7, 10, 10N, 11, 12, 14 **\$3.20/ea**
- 207MLP: LAB PAN w/METAL CLIP**, 7 1/16" x 5 5/8" x 2 3/8" Deep
 Color: 1, 2, 2N, 3, 3N, 4X, 5N, 5P, 6N, 6(O), 7, 9, 10N, 11, 12, 14 **\$4.20/ea**
- 207MLP(H): HANGING LAB PAN w/METAL CLIP**
 Color: 1, 2, 2N, 3, 7, 10N, 14 **\$5.30/ea**
- 207HS: HANGING STRIP KIT**
 Color: White, 4" Long for 1 Lab Pan **\$2.20/ea**
- NP-#: NEATEN PAN**
 White, Blue, Yellow, Rose, Purple, Black and Flame **\$5.30/ea**



MT-3020

MT-3020:
ELECTRONIC MICRO TORCH \$33.90/ea



MTC

MTC:
ELECTRONIC MICRO TORCH
Color: 2S-Aquamarin, 4S-Green, 6S-Pink, 10S-Purple, 12S-Orange \$23.30/ea



MUSLIN BUFFS White

- MBW0430** 4"x30 PLY \$3.40/ea
- MBW0440** 4"x40 PLY \$3.40/ea
- MBW0530** 5"x30 PLY \$3.40/ea
- MBW0540** 5"x40 PLY \$3.50/ea
- MBW0640** 6"x40 PLY \$4.60/ea
- MBW0650** 6"x50 PLY \$5.80/ea

MP-300

MP-200



MP-300:
OBLONG ARTICULATING MOUNTING PLATES

In Green Color, 100 pcs/bag \$106.20/bag

MP-200:
ROUND ARTICULATING MOUNTING PLATES

In Blue Color, 100 pcs/bag \$106.20/bag

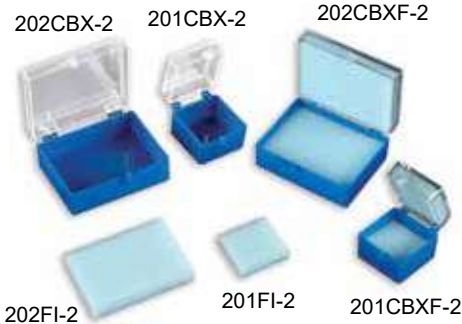

- 202CBX-2:** \$161.40/case
CLEAR TOP 1" C&B BOX
Blue, 1000 pcs/case
- 201FI-2:** \$59.70/case
FOAM INSERT FOR 1" BOX
Blue, 2000 pcs/case
- 202CBX-2:** \$120.30/case
CLEAR TOP 2" C&B BOX
Blue, 500 pcs/case
- 202FI-2:** \$43.70/case
FOAM INSERT FOR 2" BOX
Blue, 1000 pcs/case
- 201CBXF-2:** \$192.40/case
CLEAR TOP 1" C&B BOX, Blue
w / FOAM INSERT 1000 pcs/case
- 202CBXF-2:** \$159.00/case
CLEAR TOP 2" C&B BOX, Blue
w / FOAM INSERT 500 pcs/case



- 215BXL-1:** LARGE ROUND BOX/ Diameter 1 1/2" x Inner Deep 5/8"
White, 100 pcs/bag with labels \$18.20 /bag
- 215BXM-1:** MEDIUM ROUND BOX/ Diameter 1 1/2" x Inner Deep 1/2"
White, 100 pcs /bag with labels \$18.20 /bag
- 215BXS-1:** SMALL ROUND BOX/ Diameter 1 1/2" x Inner Deep 5/16"
White, 100 pcs /bag with labels \$18.20 /bag
- 215BXM-2X:** MEDIUM ROUND BOX/ Diameter 1 1/2" x Inner Deep 1/2"
Blue, 100 pcs /bag with labels \$18.20 /bag
- 215BXS-5N:** SMALL ROUND BOX/ Diameter 1 1/2" x Inner Deep 5/16"
Red, 100 pcs /bag with labels \$18.20 /bag
- 215BXL(B)-1:** LARGE ROUND BOX/ Diameter 1 1/2" x Inner Deep 5/8"
White, 1000 pcs /case \$154.30 /case
- 215BXM(B)-1:** MEDIUM ROUND BOX/ Diameter 1 1/2" x Inner Deep 1/2"
White, 1000 pcs /case \$154.30 /case
- 215BXS(B)-1:** SMALL ROUND BOX/ Diameter 1 1/2" x Inner Deep 5/16"
White, 1000 pcs /case \$154.30 /case



- SUS-001:** \$42.50/bag
MATERIAL CARTRIDGE
Clear, 100 pcs/bag
- SUS-002:** \$15.20/bag
CARTRIDGE PLUG
Blue, 100 pcs/bag
- SUS-003:** \$18.40/bag
INJECTION SOCKET
(PRESSURE PISTON)
Clear, 100 pcs/bag
- SUS-004:** \$11.70/bag
PISTON CAP
Blue, 100 pcs/bag

for **SUCCESS®** INJECTION SYSTEM

Front Surface • Mill-Ruler



MMR:
DISPOSABLE MOUTH MIRROR
Turquoise & Viola, White
100 pcs/bag \$28.30/bag



200MMR-A:
DISPOSABLE MOUTH MIRROR
Assorted 6 Bright Colors
48 pcs/bag \$14.60/bag



Finger Brush

200IT:
INFANT TOOTHBRUSH
Clear silicone material,
dishwasher safe



Gum Massager

\$3.40/ea

ORAL HYGIENE PRODUCTS



207FSD:
FLOSS DISPENSER
Beige color only **\$5.30/ea**



2350:
FLOSSII™ FLOSSERS PICKS
White, 50 bags of 4/box **\$16.40/box**



2300:
KIDSFLOSSII™ FLOSSERS
4 Assorted shapes and colors
50 bags of 4/box **\$17.40/box**



200TBX-A:
TOOTHBRUSH COVERS
Assortment of 144 covers per bag
\$19.80/bag



200TPS:
TOOTHPASTE SQUEEZERS
Assorted in 6 Bright Colors
144 pcs/bag **\$19.70/bag**



2400:
GUMPIK™ INTERDENTAL PICKS
Assortment of 6 bright colors
Box of 48 bags (48 picks/bag) **\$33.70/box**



CARTOON TOOTHBRUSH COVERS



201TBX-1:
White, 120 pcs/bag
\$20.30/bag

201TBX-A:
Assorted Colors, 120 pcs/bag
\$20.30/bag



200TC-A:
TONGUE CLEANERS
Assorted Colors
48 pcs/bag
\$15.70/bag

APPOINTMENT CARD FLOSS

Pocket Size 10 Meters Dental Floss



MINT WAXED!

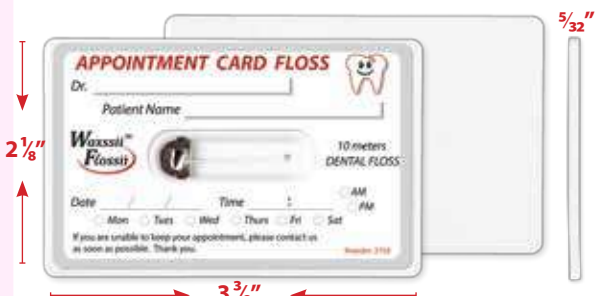

2750: REGULAR PACK
Pocket size, 10-Meter floss, Mint waxed, 20 cards/box
\$25.90/box

2750P: PERSONALIZABLE PACK
Pocket size, 10-Meter floss, Mint waxed, 20 cards + labels/box
\$25.90/box

WAXSII FLOSSII™ WAXED FLOSS

ORAL HYGIENE PRODUCTS

PREMIUM Waxed Dental Floss



2700:
FLOSS REFILL
Unflavored Waxed
200 yards/roll
\$3.30/roll



2700B:
FLOSS DISPENSER
Unflavored Waxed
200-yard floss
dispenser
\$4.40/ea



2700T:
NYLON DENTAL FLOSS
Unflavored Waxed
15-meter trial size
72 pcs/box
\$32.20/box



2800:
FLOSS REFILL
Mint Waxed
200 yards/roll
\$4.30/roll



2800B:
FLOSS DISPENSER
Mint Waxed
200-yard floss
dispenser
\$4.90/ea



2800T:
NYLON DENTAL FLOSS
Mint Waxed
15-meter trial size
72 pcs/box
\$33.20/box

SLIDI FLOSSII™ PTFE FLOSS

SLIDE Dental Floss TAPE



2900:
FLOSS REFILL
Unflavored PTFE
Tape
200 yards/roll
\$6.00/roll



2900B:
FLOSS DISPENSER
Unflavored PTFE Tape
200 yards floss
dispenser
\$7.10/ea



2900T:
PTFE DENTAL FLOSS
Slide Tape
15 Meters Trial Size
72 pcs/box
\$60.00/box

EXPANDII™ FLOSSII



3000:
FLOSS REFILL
Mint Waxed
200 yards/roll
\$5.90/roll



3000B:
FLOSS DISPENSER
Mint Waxed
200 yards floss
dispenser
\$6.80/ea



3000T:
EXPAND DENTAL FLOSS
Mint Waxed
15 Meters Trial Size
72 pcs/box
\$43.50/box



FINE™ FLOSSII



3100:
FLOSS REFILL
Mint Waxed,
UHMWPE
200 yards/roll
\$6.40/roll



3100B:
FLOSS DISPENSER
Mint Waxed
UHMWPE
200 yards floss
dispenser
\$7.30/ea



3100T:
UHMWPE FLOSS
Mint Waxed
15 Meters Trial Size
72 pcs/box
\$45.80/box

ORTHODONTIC V-SHAPED TOOTHBRUSH

20055

- Toothbrush design for plaque control during orthodontic treatment
- Central part of the 3 rows of bristles trimmed to make the brush V-shaped
- V-shape makes it easy for outer bristles to enter at the bottom of the wires where width is narrow
- Brush by covering the bracket with the recessed portion
- Can also use by inserting outer bristles under wire and brush
- Handle Material : PP + TPR • Bristles Material : Dupont Nylon

12 Brushes/Box, Assorted 4 colors

\$10.20/box



ORTHODONTIC A-SHAPED TOOTHBRUSH

20059

- Toothbrush design for plaque control during orthodontic treatment
- Outer section of the 3 rows of bristles trimmed to make the brush "A"-shaped
- Insert the brush tip under the wire and brush
- Smooth and accurate brushing of areas around orthodontic devices
- Handle Material : PP + TPR
- Bristles Material : Dupont Nylon

12 Brushes/Box, Assorted 4 colors

\$10.20/box



END-TUFTED SPECIALTY BRUSH

20050



- Remove plaque from mouth
 - Pinpoint small and hard to reach areas
 - Ergonomic handle for easy control
 - Assorted in Blue, Green, Mauve and Orange
 - 48 pcs of 1/box
- \$32.50/box**

IMPLANT & SURGERY SOFT TOOTHBRUSH

20060

- Toothbrush design for dental care during recovery from implant embedding surgery
- Suitable for cleaning areas where it is hard for normal toothbrush to reach
- Soft end-tufted bristles do not hurt affected area
- Use in conjunction with normal toothbrush
- Handle Material : PP • Bristles Material : Dupont Nylon

12 Brushes/Box, White color

\$10.20/box



20065

- Toothbrush design for dental care during recovery from implant embedding surgery
- Suitable for cleaning the affected area around the artificial tooth after implant embedding surgery
- Compact head, long neck
- Long soft bristles do not hurt the affected area, which make them suitable for dental care of the area around the implanted tooth
- Handle Material : PP • Bristles Material : Dupont Nylon

12 Brushes/Box, White color

\$10.20/box





2mm-3mm
Tapered



2000S

2050S

2000S: INTERDENAL BRUSHES
2050S: INTERDENAL ANGLE BRUSHES
Orange & Green Assorted, 50 bags of 1/box

\$16.10/box
\$19.40/box



INTERDENAL FLOSSING BRUSHES
2 mm-3 mm Tapered
Assorted in Lite Colors



2500P:
5 pcs/pack **\$1.90/pack**



2500:
100 pcs/bag **\$42.90/bag**



3mm-4mm
Tapered



2000M

2050M

2000M: INTERDENAL BRUSHES
2050M: INTERDENAL ANGLE BRUSHES
Light Blue & Mauve Assorted, 50 bags of 1/box

\$16.10/box
\$19.40/box



INTERDENAL FLOSSING BRUSHES
3 mm-4 mm Tapered
Assorted in Neon Colors



2600P:
5 pcs/pack **\$1.90/pack**



2600:
100 pcs/bag **\$42.90/bag**



3mm-7mm
Tapered



2000L

2050L

2000L: INTERDENAL BRUSHES
2050L: INTERDENAL ANGLE BRUSHES
Dark Blue & White Assorted, 50 bags of 1/box

\$16.10/box
\$19.40/box



INTERDENAL ORTHO BRUSHES
3 mm-7 mm Tapered
Assorted in Neon Colors



2650P:
5 pcs/pack **\$1.90/pack**



2650:
100 pcs/bag **\$42.90/bag**

ORAL HYGIENE PRODUCTS

DENTURE CARE BRUSH Angle Brush & Ergonomic Handle

Soft

20042 PREMIUM

Firm



20042: PREMIUM DENTURE BRUSHES
Color: Tangerine/White, Blue/White and Assorted 2 colors

\$19.70/dz.

Dual Action Brush



20040: STANDARD DENTURE BRUSHES
Color: Blue, Magenta and Assorted 2 colors

\$17.30/dz.

Flat Trimmed Brush

FULL MOUTH NIGHT GUARD

NEW



Item # MG001

Moldable: Boil and Bite
Prevent nightly teeth grinding and snoring Easily molds to the contours of your mouth for maximum comfort.

One mouth guard and complimentary case included.

\$11.30/box

NEW



20041-A: MINI DENTURE BRUSHES

Assorted 4 colors
72 pcs/box

\$33.70/box

TEETH BLEACHING TRAYS

Item # MG004

Moldable: Boil and Bite
Optimize the teeth bleaching process with a moldable bleaching tray. Easily molds to the contours of your mouth for maximum comfort.

12 bleaching trays per box

\$13.10/box



DENTAL MOUTH GUARD

MG005BA

MG005BC



Moldable: Boil and Bite
Dental mouth guard comes in two sizes:
• Small for children, teens and smaller mouths
• Large for adults

2 mouth guards and complimentary carrying case included

\$14.50/box



**ACUMIX™
CARTRIDGE
DISPENSER
GUN**

IT8-50-11:
1:1 / 2:1, 50ml

IT8-50-101:
10:1 / 4:1, 50ml

IT8-25-11:
1:1 / 25ml

\$78.60/ea

**ACUCARY™
UNIVERSAL MATERIAL CARRIER**

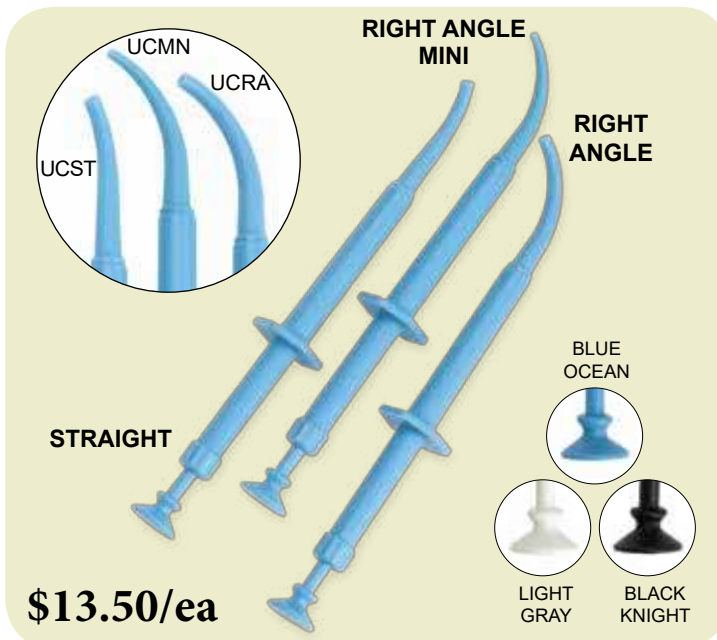

UCMN UCRA UCST

RIGHT ANGLE
MINI

RIGHT
ANGLE

BLUE
OCEAN

STRAIGHT

LIGHT
GRAY

BLACK
KNIGHT

\$13.50/ea



TP-001:
Tubes & Plugs

\$17.80/Bag

TP-002:
Needle Tubes & Plugs

\$34.90/Bag

Contains:
100 Tubes &
100 Plugs
in each bag.

Colors	STRAIGHT	RIGHT ANGLE	RIGHT ANGLE MINI
BLUE OCEAN	UCST-2P	UCRA-2P	UCMN-2P
LIGHT GRAY	UCST-9L	UCRA-9L	UCMN-9L
BLACK KNIGHT	UCST-11	UCRA-11	UCMN-11

DISPOSABLE

**ACUPUSH™
CARPULES DISPENSER GUN**



906CDG-2P 906CDG-4X 906CDG-7X 906CDG-11 906CDG-10P 906CDG-9L

***AUTOCLAVABLE UP TO 275°F \$33.20/ea**



ALIGNER TRAY SEATER
ATS #:
Color: White, Dark Blue, Bright Yellow, Green Grass, Salmon, Purple, Assorted (Blue, Yellow, Green, Salmon and Purple)
10 small bags of 2pcs (20 pcs/bag) **\$11.60/pack**



**EP2004-A:
ORTHO
ELASTIC
PLACERS**
Assorted colors
100 pcs/bag
\$11.60/bag

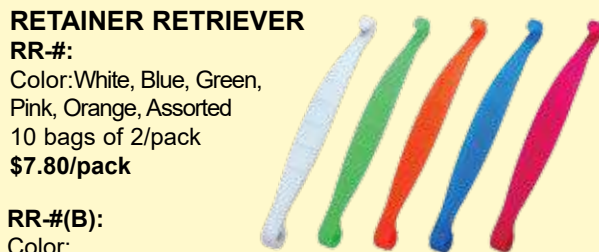

RETAINER RETRIEVER
RR #:
Color: White, Blue, Green, Pink, Orange, Assorted
10 bags of 2/pack
\$7.80/pack

RR # (B):
Color:
White, Blue, Green, Pink, Orange
100 pcs/bag **\$15.90/bag**

X-RAY PRODUCTS



XR-000:
FILM CARRIER #0 & #00
Color: White
5 pcs/box

XR-001:
FILM CARRIER #1
Color: Black
5 pcs/box

\$16.60/box

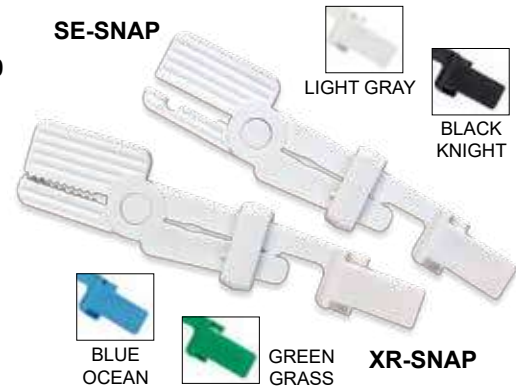

XR-SNAP:
FILM HOLDER
Color: LIGHT GRAY
BLACK KNIGHT
BLUE OCEAN
GREEN GRASS
\$11.60/box of 3

SE-SNAP:
SENSOR HOLDER
Color: LIGHT GRAY
BLACK KNIGHT
BLUE OCEAN
GREEN GRASS
\$11.60/box of 3

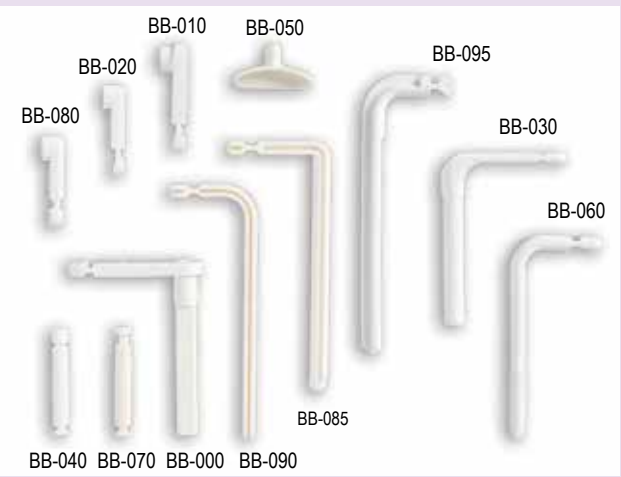

Block-4-Bite™ DISPOSABLE BITE BLOCK

BB-000:
Fits Midwest and Ritter Panorax, J. Morita Versaview Models
BB-010(7010):
Fits Siemens OP 10 Models and Instrumentarium
BB-020(7020):
Fits Siemens OP 3, OP 5 Models
BB-030(7030):
Fits Phillips, Den-Tal-Ez Panolite, Soredex
BB-040(7040):
Fits GE Panolipse and Gendex Models
BB-050(7050):
Fits Yoshida, Kaycor Panoura Models
BB-060(7060):
Fits Planmeca Models

BB-070(7070):
Fits Panorex by Keystone
BB-080(7080):
Fits Belmont Autopan, FIAD Rotograph
BB-085(7085):
Fits Yoshida, Kaycor Panoura Models, New "L" Shape
Design can Replace Model BB-050
BB-090(7090):
Fits Belmont X-Caliber Models
BB-095(7095):
Fits Panoramic Corporation

100 pcs/box, **\$39.50/box**



SE-9913:
Replacement Short Bands
for XCP-DS FIT



SE-9914:
Replacement Long Bands
for XCP-DS FIT

6 pcs/bag **\$21.00/bag**



FILM ALIGNING SYSTEM

XR-0934: BITEWING RING(Red)
XR-0865: ANTERIOR RING(Blue)
XR-0860: POSTERIOR RING(Yellow) **\$6.20/ea**

Autoclavable to 250° F

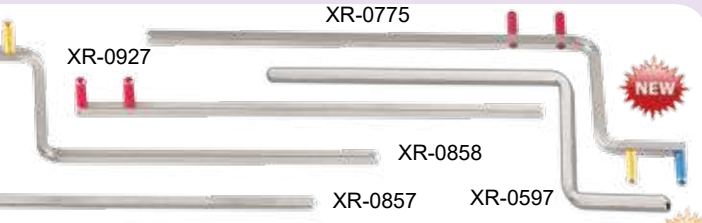
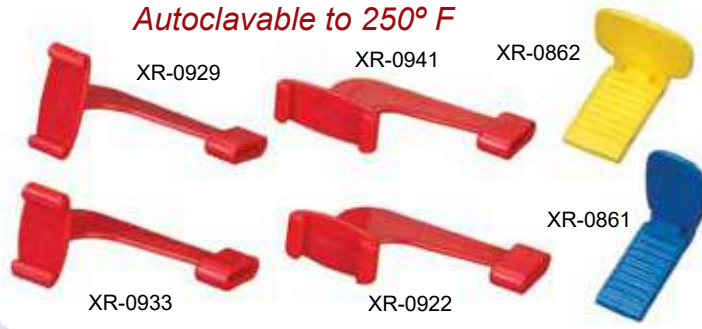

XR-0927: BITEWING ARM(Red)
XR-0857: ANTERIOR ARM(Blue)
XR-0858: POSTERIOR ARM(Yellow) **\$21.70/ea**
XR-0597: ENDO ARM(No Pins) **\$20.20/ea**
XR-0775: UNIVERSAL ARM **\$28.20/ea**

XR-0933: BITEWING BITE BLOCKS(Red,H0/1)
XR-0929: BITEWING BITE BLOCKS(Red,H2)
XR-0922: BITEWING BITE BLOCKS(Red,V1)
XR-0941: BITEWING BITE BLOCKS(Red,V2)
XR-0861: ANTERIOR BITE BLOCKS(Blue)
XR-0862: POSTERIOR BITE BLOCKS(Yellow) **\$13.70/bag of 25**

XR-FAS: COMPLETE ALIGNING SYSTEM
4 Arms, 4 Rings, 17 Bite Blocks **\$98.50/box**



CRH-2:
COTTON ROLL HOLDERS
Disposable, Blue
\$13.80/bag of 100



CRH-ST:
STAINLESS STEEL
COTTON ROLL HOLDERS
4 pcs/box \$14.50/box



EX-9050: Large(Adult), White, 48 pcs/bag \$13.70/bag
EX-9040: Medium(Child), White, 48 pcs/bag \$13.70/bag
EX-9060: Small(Pedo), White, 48 pcs/bag \$13.70/bag

SILICONE MOUTH PROPS



Latex Free!

EXTND™ MOUTH PROPS

- RB-9040-9:**
EXTND™ RUBBER MOUTH PROPS /Large(Adult), Dark Gray, Autoclavable to 260°F, 2 pcs/box \$16.30/box
- RB-9050-9:**
EXTND™ RUBBER MOUTH PROPS /Medium(Child), Dark Gray, Autoclavable to 260°F, 2 pcs/box \$16.30/box
- RB-9060-9:**
EXTND™ RUBBER MOUTH PROPS /Small(Pedo), Dark Gray, Autoclavable to 260°F, 2 pcs/box \$16.30/box
- SC-9040-7X:**
EXTND™ SILICONE MOUTH PROPS /Large(Adult), Orange, Autoclavable & Dry Heat to 500°F, 2 pcs/box \$21.60/box
- SC-9050-7X:**
EXTND™ SILICONE MOUTH PROPS /Medium(Child), Orange, Autoclavable & Dry Heat to 500°F, 2 pcs/box \$21.60/box

- SC-9060-7X:**
EXTND™ SILICONE MOUTH PROPS /Small(Pedo), Orange, Autoclavable & Dry Heat to 500°F, 2 pcs/box \$21.60/box
- SC-9040-10X:**
EXTND™ SILICONE MOUTH PROPS /Large(Adult), Dark Purple, Autoclavable & Dry Heat to 500°F, 2 pcs/box \$21.60/box
- SC-9050-4T:**
EXTND™ SILICONE MOUTH PROPS /Medium(Child), Turquoise, Autoclavable & Dry Heat to 500°F, 2 pcs/box \$21.60/box
- SC-9060-3N:**
EXTND™ SILICONE MOUTH PROPS /Small(Pedo), Neon Yellow, Autoclavable & Dry Heat to 500°F, 2 pcs/box \$21.60/box
- SC-9020-11:**
EXTND™ SILICONE MOUTH PROPS /Edentulous Autoclavable & Dry Heat to 500°F, 2 pcs/box \$28.10/box
- SC-9030-11:** **Extra Large Adult** 2 pcs/box \$28.10/box
- EXTND™ SILICONE MOUTH PROPS** /Extra Large Adult Autoclavable & Dry Heat to 500°F, 2 pcs/box \$28.10/box

ACUWELL™ UNIVERSAL MATERIAL WELL



***AUTOCLAVABLE UP TO 275°F \$5.30/ea**



***AUTOCLAVABLE**
WEDGE w/GUARD
WGD-L Large **WGD-M** Medium
WGD-S Small
\$6.60/box of 10 pcs

ACUWEDGE™ PLASTIC WEDGES



WG-16 16mm **WG-14** 14mm **WG-12** 12mm **WG-10** 10mm
WG-A: 4 Assorted Sizes 25 pcs each size ***DISPOSABLE**
Single Size 100 pcs/box **\$8.50/box**



MUR-M

MUR-S

MOUTH RING RETRACTORS

MUR-M:

Regular
20 pcs/box

MUR-S:

Small
20 pcs/box

\$32.00/box



LR-L

LR-S

LIP RING RETRACTORS

LR-L:

Adult, 10 pcs/bag
\$7.00/bag

LR-S:

Child, 10 pcs/bag
\$7.00/bag

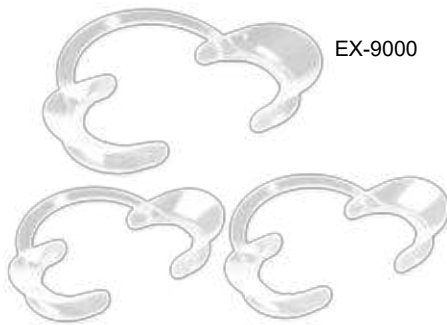

EX-9000

EX-9001

EX-9001T

EXTND™ HANDFREE CHEEK RETRACTORS
Autoclavable to 275°F

EX-9000:

Adult, 2 pcs/box

EX-9001:

Child, 2 pcs/box

EX-9001T:

Teen, 2 pcs/box

\$10.50/box

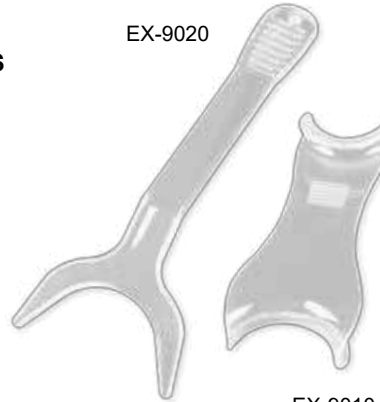

EX-9020

EX-9010

EXTND™ PHOTOGRAPHY CHEEK RETRACTOR
Autoclavable to 275° F

EX-9010:

Double Ended,
2pcs/box

\$12.60/box

EX-9020:

Vertical Use,
2pcs/box

\$12.60/box



EX-9004

EX-9005

EXTND™ DOUBLE ENDED CHEEK RETRACTOR

Autoclavable to 250° F

EX-9004:

Large Size, Clear, 2pcs/box

EX-9005:

Small Size, Clear, 2pcs/box

\$10.50/box

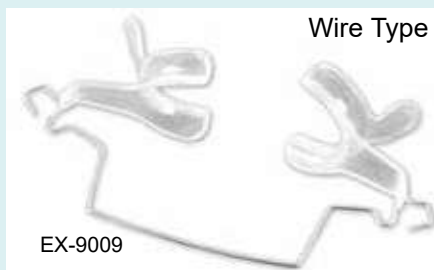

Wire Type

EX-9009

EXTND™ WIRE TYPE CHEEK RETRACTOR

Autoclavable to 250° F

EX-9009:

Clear, 1pcs/box **\$11.20/box**



EX-9002

EX-9003

EXTND™ HANDHOLD CHEEK RETRACTORS Autoclavable to 275°F

EX-9002:

Adult, 2 pcs/box

\$7.40/box

EX-9003:

Child, 2 pcs/box

\$7.40/box

EXTND™ INTRAORAL DISPOSABLE CHEEK RETRACTOR

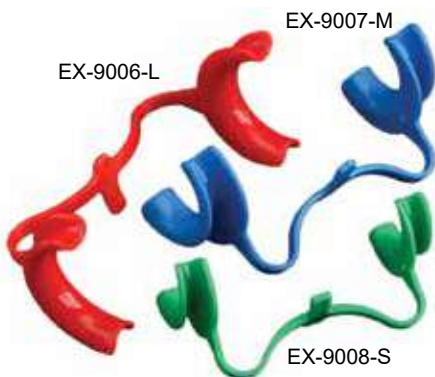

EX-9007-M

EX-9006-L

EX-9008-S

EX-9006-L:

Large Size, Red

EX-9007-M:

Medium Size, Blue

EX-9008-S:

Small Size, Green

10 pcs/bag

\$9.30/bag

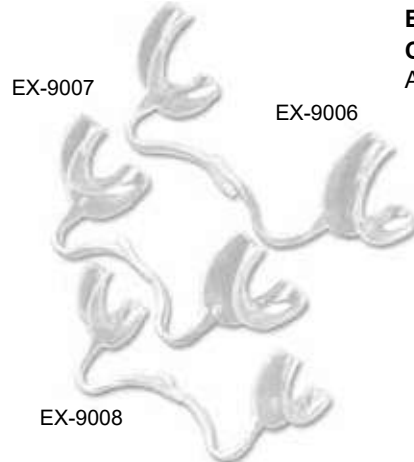

EX-9007

EX-9006

EX-9008

EXTND™ INTRAORAL CHEEK RETRACTOR

Autoclavable to 275° F

EX-9006:

Large Size, 2pcs/box

\$10.50/box

EX-9007:

Medium Size, 2pcs/box

\$10.50/box

EX-9008:

Small Size, 2pcs/box

\$10.50/box

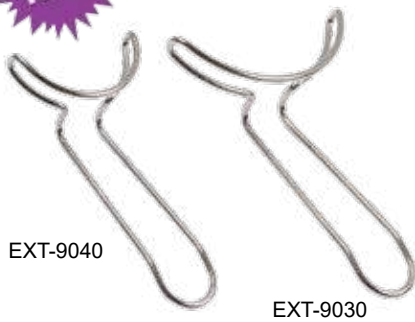

**VESTIBULUM CHEEK RETRACTOR
STAINLESS STEEL**

EXT-9030:
Size: Large **\$12.50/ea**

EXT-9040:
Size: Regular **\$12.50/ea**

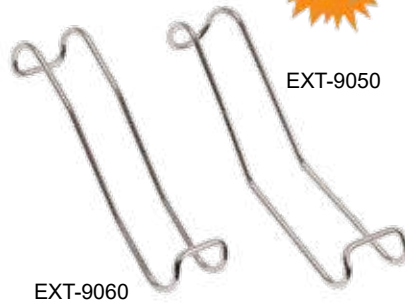

**COLUMBIA CHEEK RETRACTOR
STAINLESS STEEL**

EXT-9050:
Size: Adult **\$12.50/ea**

EXT-9060:
Size: Child **\$12.50/ea**



IT8-APP:
CAPSULE APPLIER, Universal **\$58.20/ea**
IT8-ACT:
ACTIVATOR, for 3M APLICAP **\$58.20/ea**

ORINGER MOUTH GAP STAINLESS STEEL

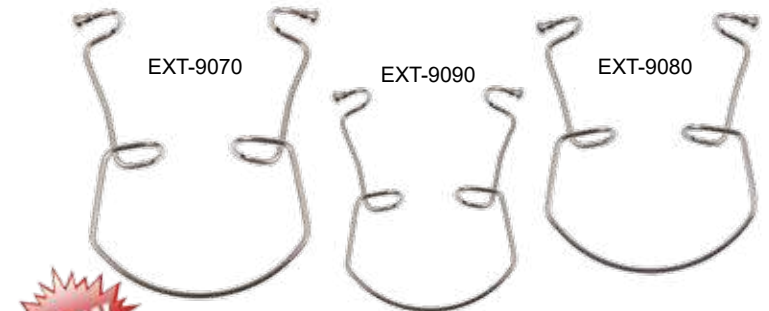

EXT-9070: Size: Large **\$14.50/ea**
EXT-9080: Size: Medium **\$14.50/ea**
EXT-9090: Size: Small **\$14.50/ea**

LIGHT HANDLES

Item#: LHD-001

- Compatible with DCI/Marus 1200 operatory lights
- Sold as set of two handles: 1 left and 1 right

\$18.00/Set

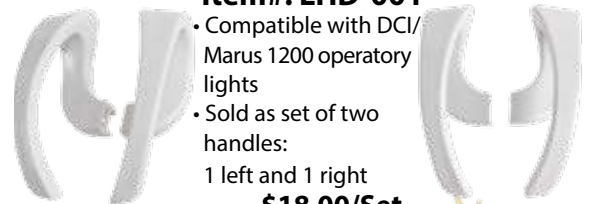

LIGHT SPLASH SHIELDS

LSS-001
PREMIUM LIGHT SPLASH SHIELDS
for DCI/Marus1200 **\$28.70/ea**

LSS-002
PREMIUM LIGHT SPLASH SHIELDS
for A-Dec **\$28.70/ea**

LSS-600
LIGHT SPLASH SHIELDS
for Pelton & Crane LF I **\$10.90/ea**

LSS-601
LIGHT SPLASH SHIELDS
for Pelton & Crane LF II **\$11.90/2 pcs**

LSS-602
LIGHT SPLASH SHIELDS
for Ritter Starlite "J" & "K" **\$14.90/ea**

LSS-603
LIGHT SPLASH SHIELDS
for Belmont 046, 047, 048, 049 **\$10.70/ea**

LSS-631
LIGHT SPLASH SHIELDS
for Belmont X-Calibur, Aristocrat **\$10.70/ea**



LSS-002

LSS-001



LSS-602

LSS-600



LSS-603

LSS-631

LSS-601

INTRAORAL PHOTOGRAPHY

CONTRASTERS

PALATAL CONTRASTERS



IPM-4CA
\$35.30/ea

IPM-4CB
\$35.30/ea

OCCLUSAL CONTRASTERS



IPM-4CC
\$35.30/ea

IPM-4CD
\$35.30/ea

MULTI-PURPOSE CONTRASTERS

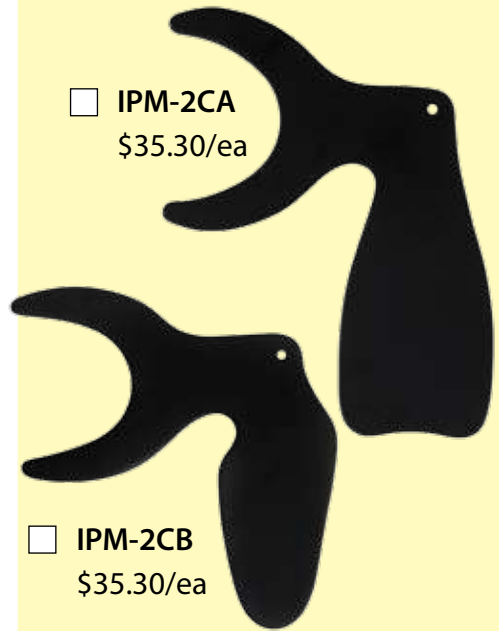

IPM-2CA
\$35.30/ea

IPM-2CB
\$35.30/ea

- Black anodized aluminum
- For film and digital photography
- Contrast images and eliminate unrequired elements

IPM-4CADC CONTRASTER SET (4PCS/SET) with size IPM-4CA, IPM-4CB, IPM-4CC, IPM-4CD \$126.50/set

OCCLUSAL CONTRASTERS

BUCCAL & LINGUAL CONTRASTERS

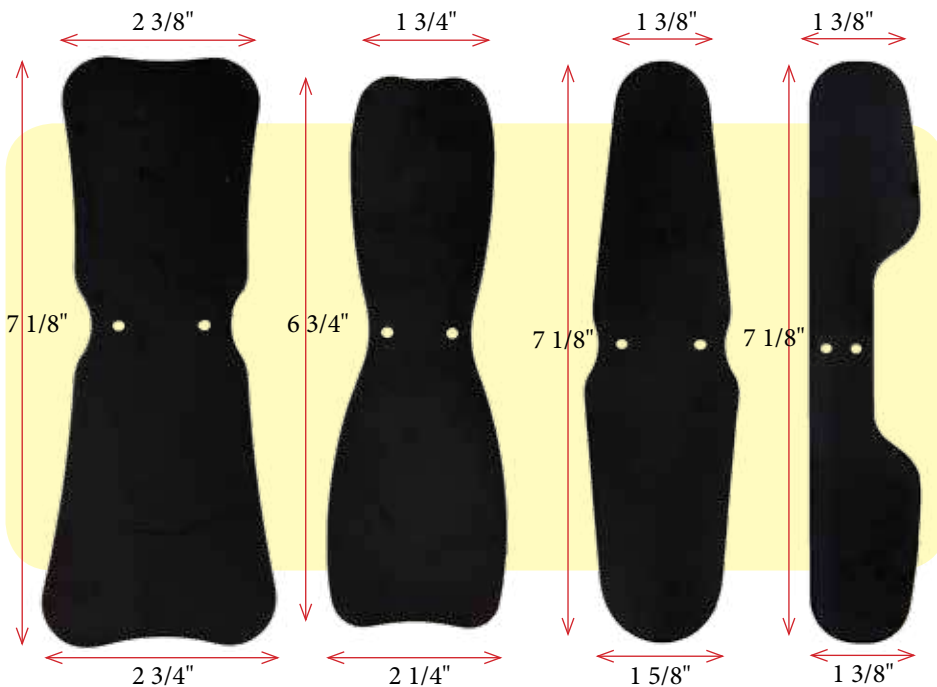

- Improve photo quality
- Can help indicate incisal translucency
- Creates more presentable photo to show patients
- Black anodized aluminum
- For film and digital photography
- Contrast images and eliminate unrequired elements

\$35.30/ea

IPM-3CA
OCCLUSAL/ADULT

IPM-3CB
OCCLUSAL/CHILD

IPM-3CC
BUCCAL

IPM-3CD
LINGUAL

PHOTOGRAPHY MIRRORS

- Highly polished reflective mirror surface
- Unbreakable ultimate durability
- Fully sterilizable

ONE-SIDED STAINLESS STEEL

OCCLUSAL MIRRORS

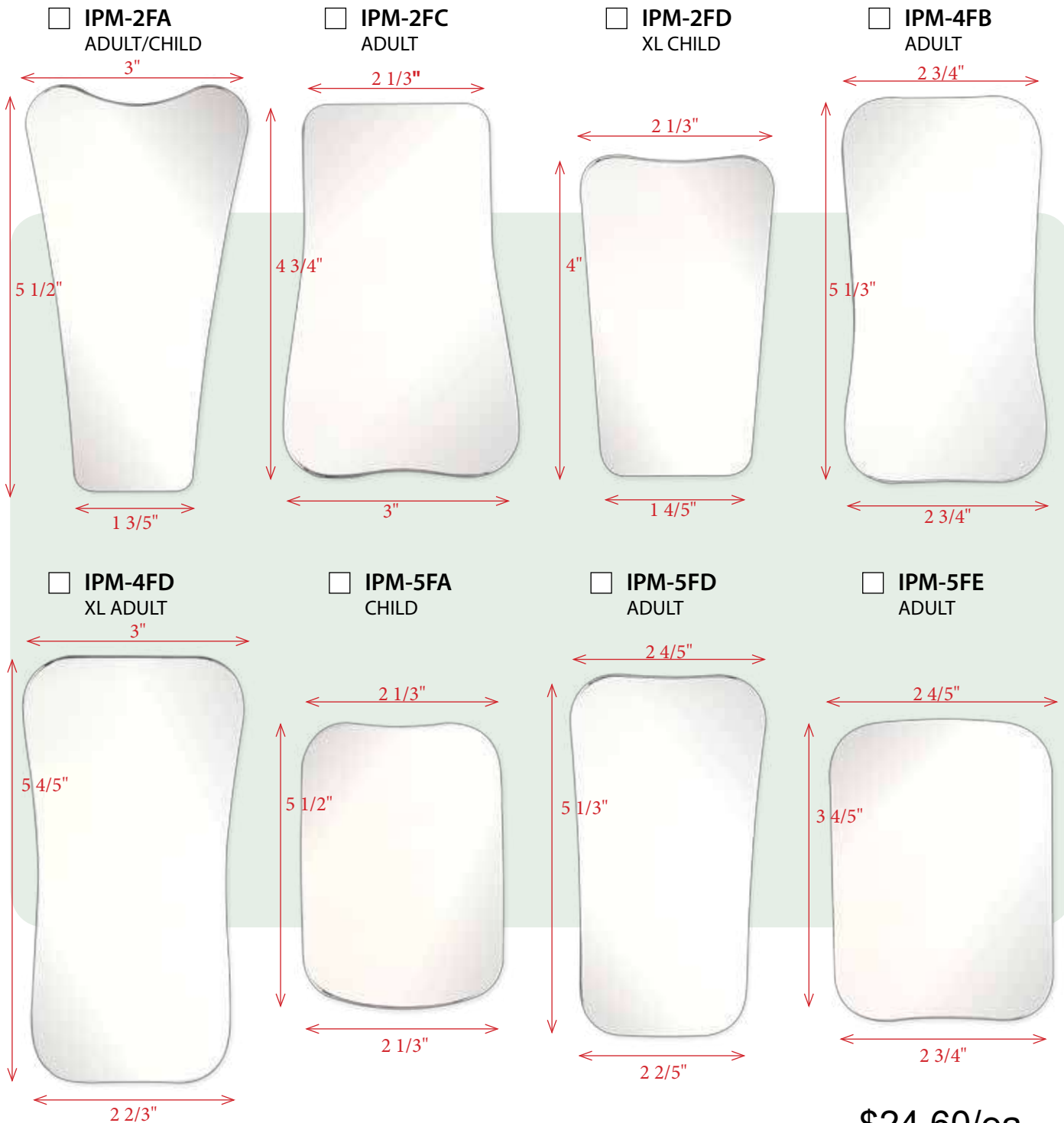

\$24.60/ea

INTRAORAL PHOTOGRAPHY PHOTOGRAPHY MIRRORS

ONE-SIDED STAINLESS STEEL

BUCCAL & LINGUAL MIRRORS

\$24.60/ea

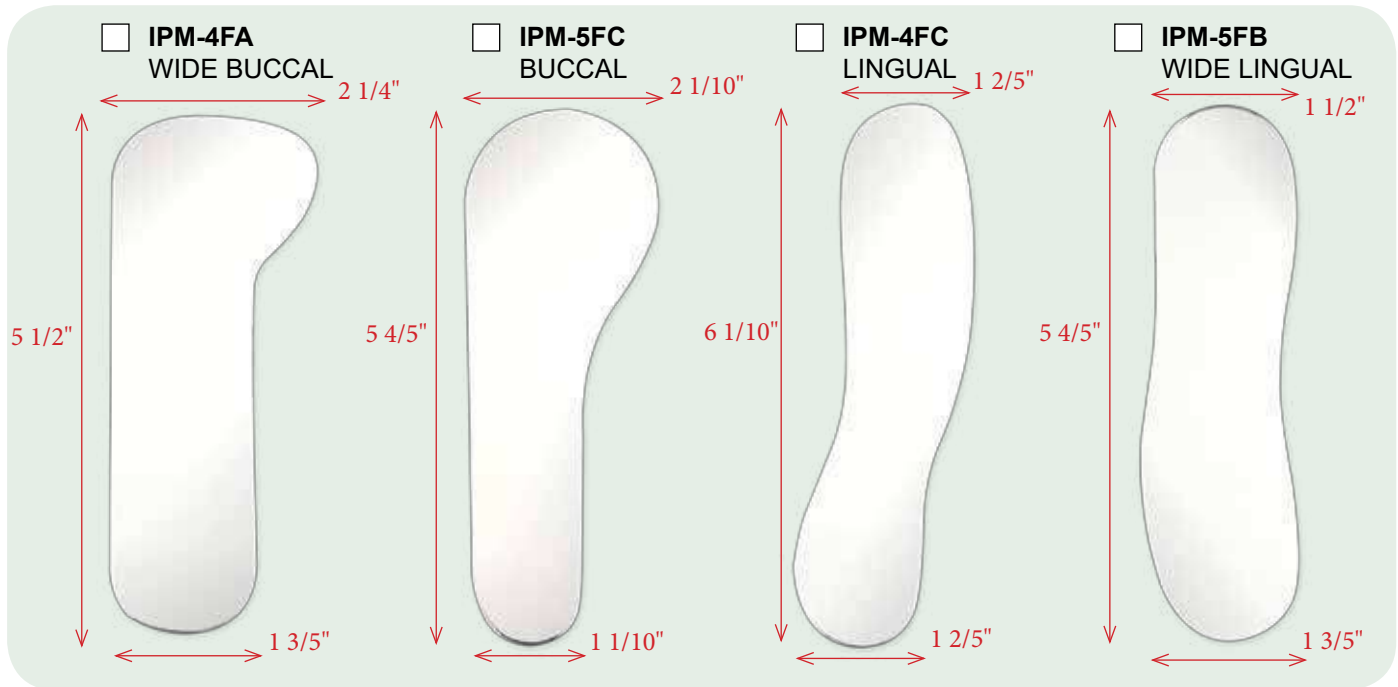

TWO-SIDED STAINLESS STEEL PHOTOGRAPHY MIRRORS

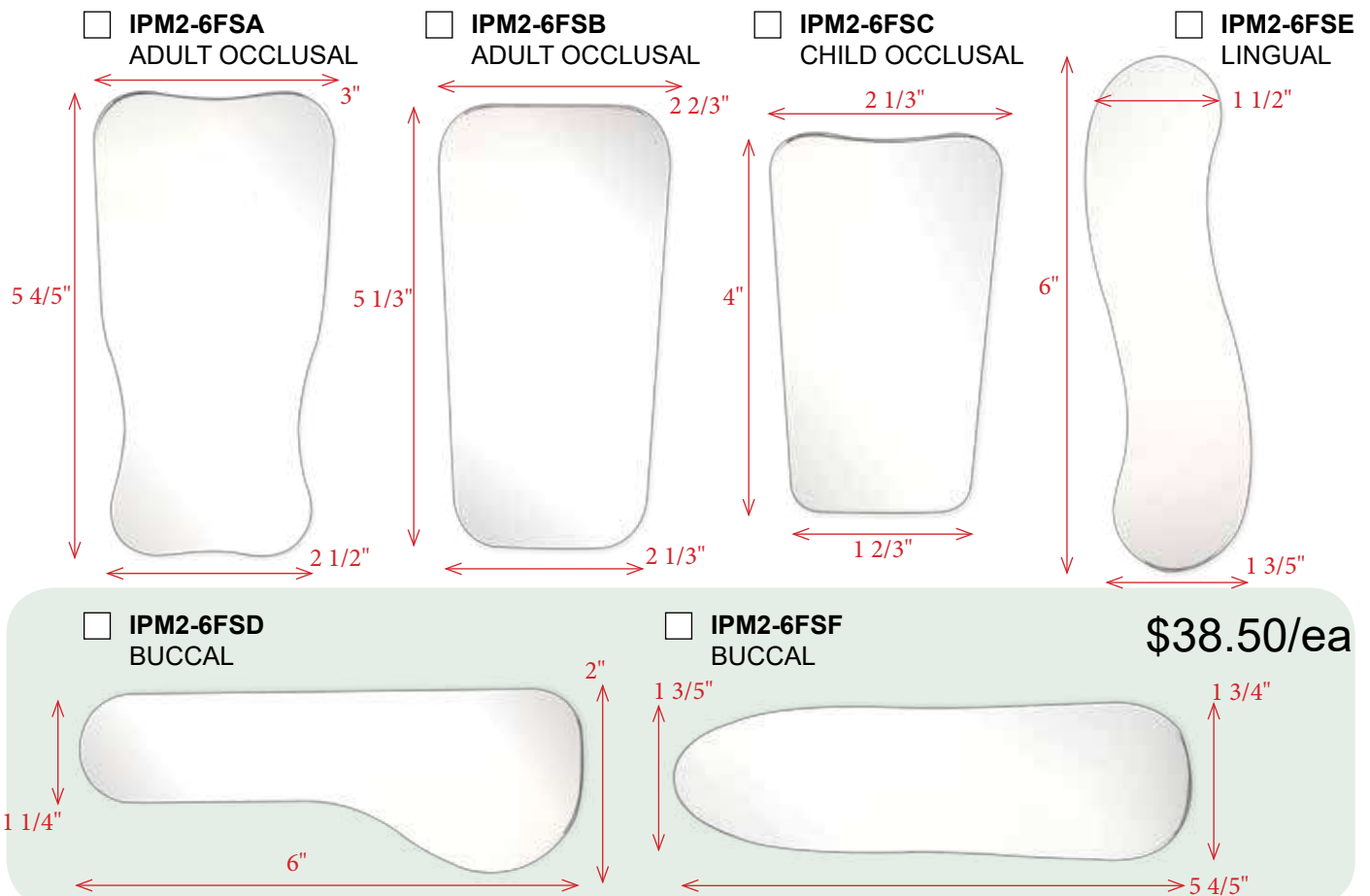

ANGLED PHOTOGRAPHY MIRRORS

- 150° mirror surfaces to eliminate double reflections
- Avoid hand interference
- Highly polished stainless steel fully sterilizable

ONE-SIDED MIRROR SURFACE

\$29.10/ea

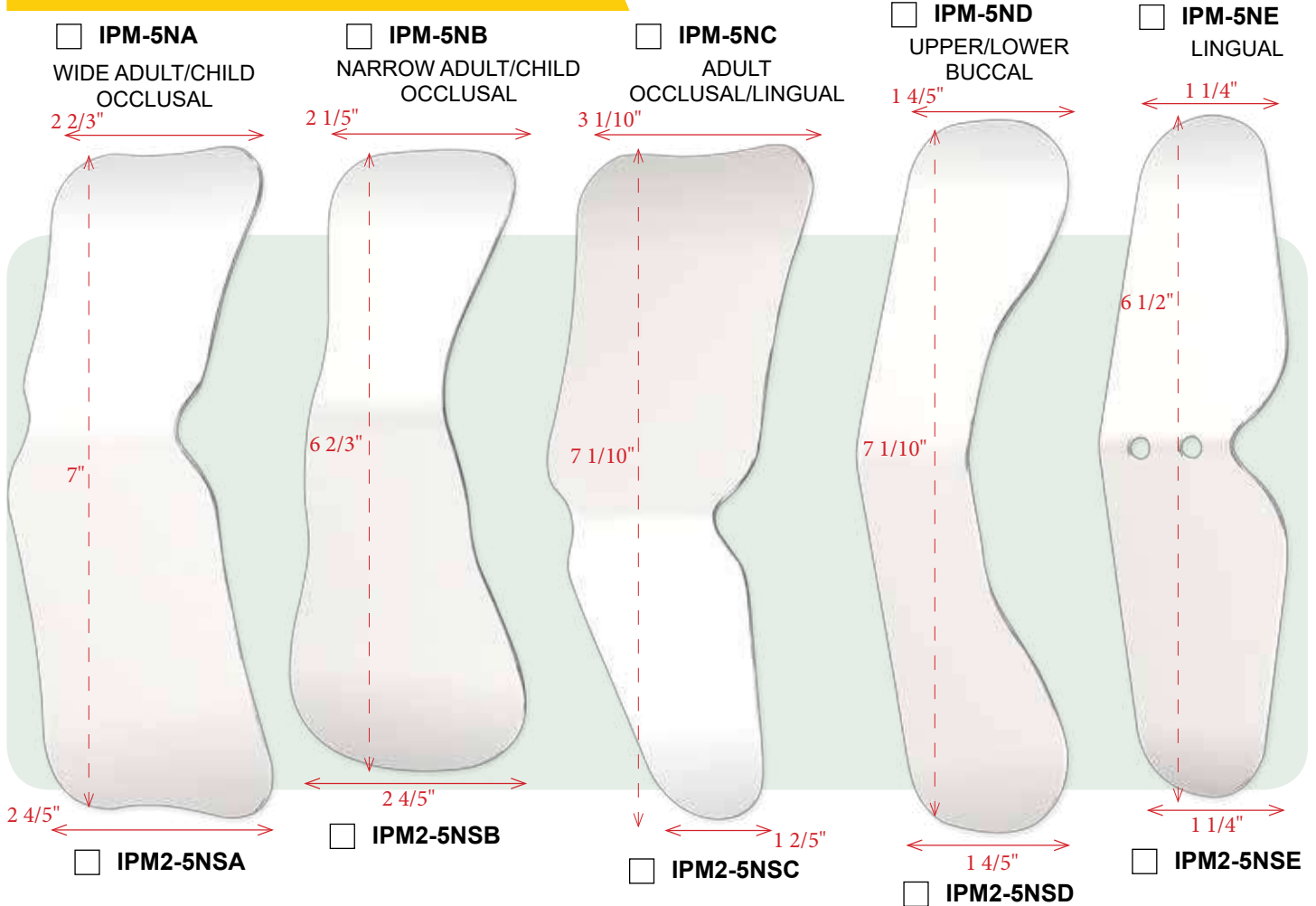

TWO-SIDED MIRROR SURFACE

\$49.40/ea

- IPM-5NANE** ONE-SIDED MIRRORS SET (5 PCS/SET)
 with size IPM-5NA, IPM-5NB, IPM-5NC, IPM-5ND, IPM-5NE **\$127.20/set**
- IPM2-5NSANSE** TWO-SIDED MIRRORS SET (5 PCS/SET)
 with size IPM2-5NSA, IPM2-5NSB, IPM2-5NSC, IPM2-5NSD, IPM2-5NSE **\$222.30/set**

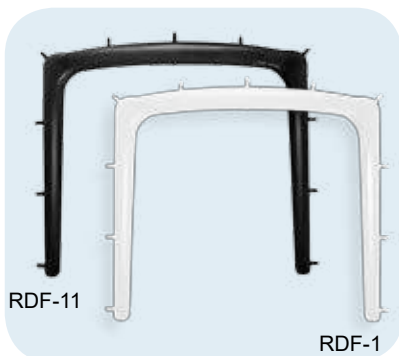

NEW NYLON RUBBER DAM FRAME

RDF-1:
 Color: White,
 Radiopaque
\$5.00/ea

RDF-11:
 Color: Black,
 Radiolucent
\$8.10/ea



DENTAL DAM STABILIZING CORD

RDS-12
 Medium (1.8 mm)
 6 5/6' (2.1 m)
\$6.90/ea



More Colors • Pay Less •



969 Price Street
Pomona CA 91767 U.S.A
Tel. (909)620-0289 Fax. (909)623-1449
Toll Free Fax. 1-800-392-0712
information@plasdent.com

